

10

RIGGING ELEMENT

A10i-LIFT

3D View

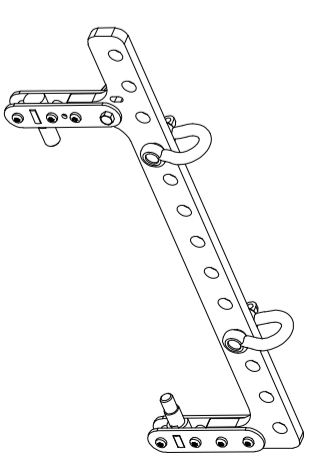

J

I

H

G

F

E

D

C

B

A

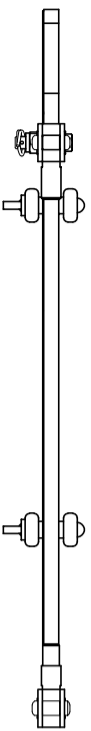

475
[18.7"]

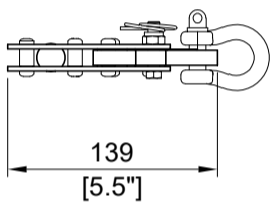
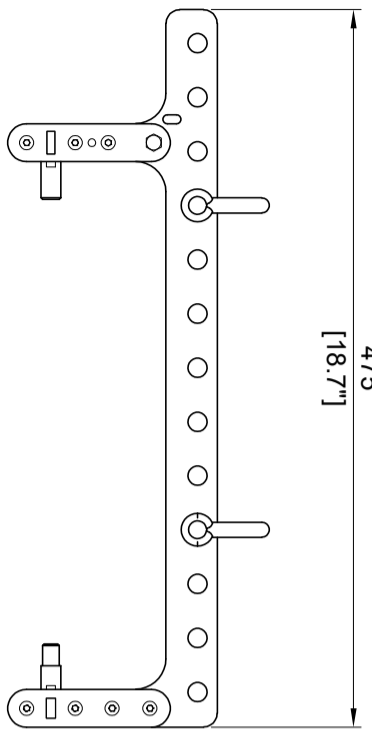

139
[5.5"]

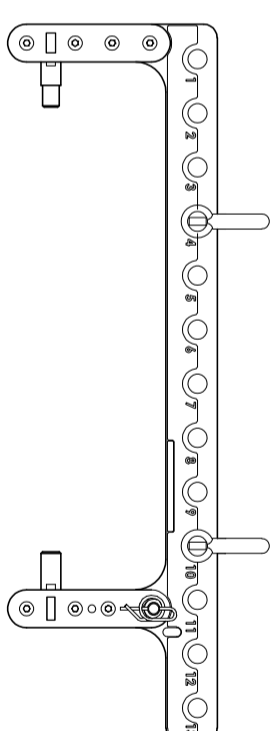

38
[1.5"]

25
[1"]

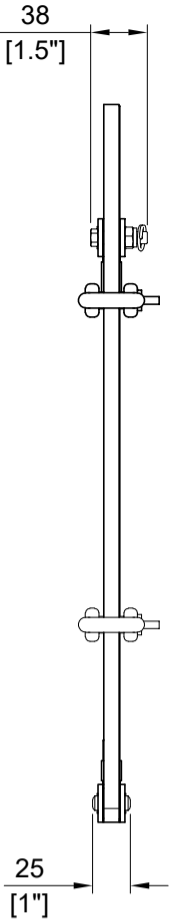

Drawn by:	DAVID LY
Date:	2020-03-20
Scale:	1/5
Format:	A3
Weight (kg/lbs):	2 Kg / 4.4 lb

Referential axis of symmetry

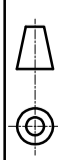

Rev.	Date:	Modifications:



13 Rue Levecher Central
Parc de la Fontaine de Jourvance
91462 MARCOUSSIS CEDEX
- FRANCE -
Tel: +33 (0)1 69 63 69 63
Fax: +33 (0)1 69 63 69 64
Email: application@l-acoustics.com

These drawings are the property of LACOUSTICS. All reproduction, copy or communication is forbidden without written permission.

1

2

3

4

5

6

7

8

9

J

I

H

G

F

E

D

C

B

A

1

2

3

4

5

6

7

8

9