

J

I

H

G

F

E

D

C

B

A

RIGGING ELEMENT

K2-JACK

3D View

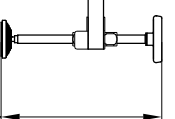
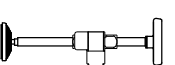
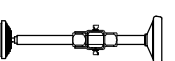
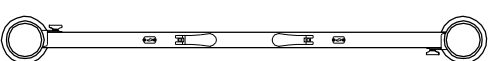
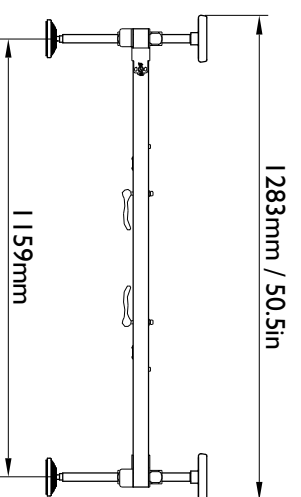
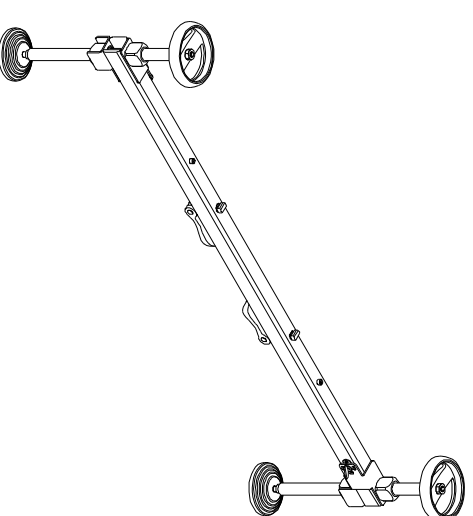

124mm / 4.9in

426mm / 16.8in

Drawn by:

DAVID.LY

Date:

2014-01-28

Scale:

1/20 Dim: mm / inches

Format:

A3 Weight (kg/lbs): 10.1 Kg / 22.3lbs

 Referential axis of symmetry

Rev:	Date:	Modification:



13 Rue Levacher-Girtrac
Parc de la Fontaine de Jouvaux
91462 MARCOUSSIS CEDEX
- FRANCE -
Tel: +33 (0)1.69.63.69.63
Fax: +33 (0)1.69.63.69.64
Email: application@l-acoustics.com

These drawings are the property of LACOUSTICS. All reproduction, copy or communication is forbidden without written permission.

2

3

4

5

6

7

8

9

10

1

J

I

H

G

F

E

D

C

B

A

2

3

4

5

6

7

8

9

10

1