

# LC 16D

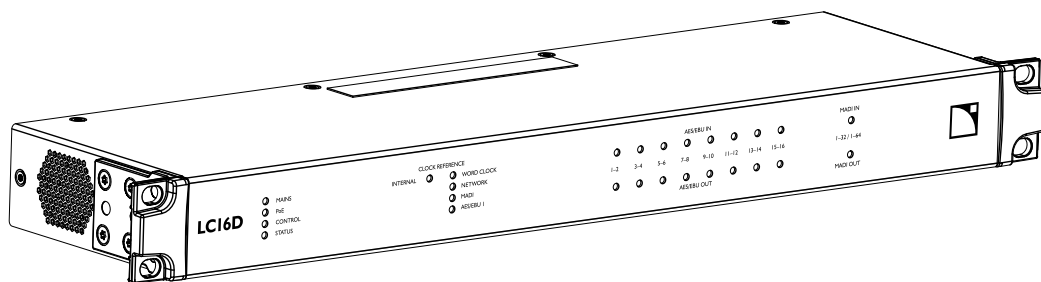

owner's manual (EN)



Document reference: LC16D owner's manual (EN) version 2.0

Distribution date: February 6, 2024

© 2024 L-Acoustics. All rights reserved.

No part of this publication may be reproduced or transmitted in any form or by any means without the express written consent of the publisher.

## Contents













|                                    |    |
|------------------------------------|----|
| Safety.....                        | 5  |
| Important safety instructions..... | 5  |
| Introduction.....                  | 7  |
| LC16D Network audio converter..... | 7  |
| How to use this manual.....        | 7  |
| Revision history.....              | 8  |
| System components.....             | 8  |
| Technical description.....         | 9  |
| Main features.....                 | 9  |
| Front and rear panels.....         | 9  |
| Power supply.....                  | 10 |
| Signal processing.....             | 10 |
| Signal inputs and outputs.....     | 10 |
| Mapping.....                       | 11 |
| Monitoring and control.....        | 12 |
| User interface.....                | 12 |
| Remote control.....                | 12 |
| Installation.....                  | 13 |
| Mounting.....                      | 13 |
| Ventilation.....                   | 13 |
| General Purpose I/O (GPIO).....    | 14 |
| Power over Ethernet.....           | 15 |
| Connecting to AC mains.....        | 15 |
| Electrical specifications.....     | 15 |
| Power cord.....                    | 16 |
| Plugging LC16D.....                | 16 |
| Power consumption.....             | 16 |
| Audio and network cabling.....     | 16 |
| Connectors.....                    | 16 |
| AES/EBU audio.....                 | 17 |
| MADI audio.....                    | 18 |
| Word clock.....                    | 18 |
| Milan-AVB.....                     | 19 |
| Cabling examples.....              | 20 |

|  |    |
|--|----|
| Operation.....                         | 21 |
| Powering on/off.....                   | 21 |
| Interpreting the front panel LEDs..... | 21 |
| LC16D embedded Web interface.....      | 26 |
| Top bar.....                           | 26 |
| Audio overview.....                    | 27 |
| AVB input mapping.....                 | 32 |
| AVB output mapping.....                | 33 |
| GPIO.....                              | 34 |
| Settings.....                          | 36 |
| Additional actions.....                | 39 |
| Specifications.....                    | 40 |
| LC16D.....                             | 40 |

# Safety

## Important safety instructions

---

- 
**Inspect the product before operation.**  
 If any sign of defect or damage is detected, immediately withdraw the product from use for maintenance.
- 
**Perform preventive maintenance at least once a year.**  
 Refer to the preventive maintenance section for a list of actions and their periodicity.  
 Insufficient upkeep of the product can void the warranty.
- 
**Verify the electrical conformity and compatibility of the mains supply.**  
 Only connect the product to an AC power outlet rated 100-240 V, 50-60 Hz.  
 The product draws 8 W (typical).  
**WARNING:** The product is of Class 1 construction and shall be connected to a mains socket outlet with a Protective Earth connection.
- 
**When the product is used in a three-phase circuit, verify the electrical conformity and compatibility of the three-phase circuit.**  
 Verify that the three phases work, and balance the loads between the three phases.  
 Verify that the neutral and earth work.  
 Never try to emulate a 230 V circuit connecting an apparatus to two live wires of a 120 V three-phase circuit.  
 Never try to emulate a 200 V circuit connecting an apparatus to two live wires of a 100 V three-phase circuit.
- 
**Electrical generator**  
 You must power on the generator before powering on the product.  
 Verify that the product is turned off before powering on the generator.
- 
**Never incorporate equipment or accessories not approved by L-Acoustics.**  
**Read all the related PRODUCT INFORMATION documents shipped with the products before exploiting the system.**
- 
**Intended use**  
 This system is intended for use by trained personnel for professional applications.
- 
**As part of a continuous evolution of techniques and standards, L-Acoustics reserves the right to change the specifications of its products and the content of its documents without prior notice.**  
 Check [www.l-acoustics.com](http://www.l-acoustics.com) on a regular basis to download the latest document and software updates.
- 
**Do not use the product outside its operating temperature range.**  
 The product operates at a room temperature between -5 °C / 23 °F and 50 °C / 122 °F.  
 Do not expose the product to direct sun.
- 
**Do not expose the product to extreme conditions.**  
 Do not expose the product to moisture (rain, mist, sea spray, steam, humidity, condensation...) or excessive heat (direct sun, radiator...) for a long period of time.  
 For more information, refer to the **Products weather protection** document, available on the website.
- 
**Use the product in a conformed electro-magnetic environment.**  
 The product can be used in the following environment: residential (class B).  
**Avoid radio interference.**  
 This product has been tested and complies with the regulations of the EMC directive (Electro Magnetic Compatibility). These regulations are designed to provide reasonable protection against harmful interference from electrical equipment, but it cannot be guaranteed that interference will never occur.
- 
**Product disconnection**  
 To completely disconnect this product from the mains, disconnect the power supply cord plug from the mains socket outlet.

- ! Power supply cord and socket accessibility**  
The main plug of the power supply cord shall remain easily accessible.  
The mains socket outlet shall be easily accessible.
- ! Read the maintenance section of this document before servicing the product.**
- ! Contact L-Acoustics for advanced maintenance.**  
Any unauthorized maintenance operation will void the product warranty.
- ! Shipping**  
Use the original packaging for shipping the product, unless it is mounted in a rack with the front fixed to the rack, as described in this manual.

## Symbols on the product

---



### Explanation of graphical symbols



The lightning flash with arrowhead symbol within an equilateral triangle is intended to alert the user to the presence of uninsulated "dangerous voltage" within the product's enclosure that may be of sufficient magnitude to constitute a risk of electric shock to persons.



The exclamation point within an equilateral triangle is intended to alert the user to the presence of important operating and maintenance instructions in the literature accompanying the product.



Do not open unless authorized. This symbol indicates the presence of electrical shock hazards. It also indicates that no maintenance performed by the end user requires access to internal components.



This marking indicates that this product should not be disposed of with other household waste throughout the EU. To prevent possible harm to the environment or human health from uncontrolled waste disposal, recycle it responsibly to promote the sustainable reuse of material resources. To return your used device, please use the return and collection systems or contact the retailer where the product was purchased. They can take this product for environmentally safe recycling.

# Introduction

## LC16D Network audio converter



LC16D is a multichannel converter that bridges MADI and AES/EBU legacy digital formats bidirectionally with a Milan-AVB network. Supporting up to 128 Milan-AVB inputs and outputs simultaneously, LC16D offers dynamic mapping of channels, and comprehensive synchronization options, with remote control via a simple to use embedded web interface. Flexible power options and seamless Milan-AVB network audio connections deliver robust redundancy features as standard, all housed in a compact and rugged 1RU chassis.

Up to 16 AES/EBU inputs and outputs can be connected using standard DB25 connectors. Asynchronous sample rate converters (ASRC) are implemented on each AES/EBU input. A pair of BNC connectors provide access to MADI. At a sampling rate of 96 kHz, 32 input and 32 output channels are supported, and up to 64 at 48 kHz. Used together, up to 80 input sources and 80 output destinations can be connected and dynamically mapped to and from a redundant Milan-AVB network. The comprehensive clocking options facilitate the selection of a reference from any of six different sources, which is then presented to all outputs, enabling clock distribution across a system. Up to three levels of power redundancy are available using a combination of the internal PSU and the dual, PoE-supporting, Ethernet ports.

## How to use this manual

The LC16D owner's manual is intended for all actors involved in the system design, implementation, preventive and corrective maintenance of the LC16D product. It must be used as follows:

1. Read the technical description for an overview of all product elements, their features, and their compatibilities.
  - [Technical description](#) (p.9)
2. Before installing the product, perform mandatory inspections and functional checks.
3. To deploy the product, follow the step-by-step installation instructions and refer to the cabling schemes.
  - [Installation](#) (p.13)
  - [Audio and network cabling](#) (p.16)
4. To configure the settings and parameters of the product, follow the step-by-step operation instructions.
  - [Operation](#) (p.21)

**As part of a continuous evolution of techniques and standards, L-Acoustics reserves the right to change the specifications of its products and the content of its documents without prior notice.**

Check [www.l-acoustics.com](http://www.l-acoustics.com) on a regular basis to download the latest document and software updates.





## Contact information

For information on advanced corrective maintenance:

- contact your Certified Provider or your L-Acoustics representative
- for Certified Providers, contact the L-Acoustics customer service: [customer.service@l-acoustics.com](mailto:customer.service@l-acoustics.com) (EMEA/APAC), [laus.service@l-acoustics.com](mailto:laus.service@l-acoustics.com) (Americas).

## Symbols

The following symbols are used in this document:

-  This symbol indicates a potential risk of harm to an individual or damage to the product. It can also notify the user about instructions that must be strictly followed to ensure safe installation or operation of the product.
-  This symbol indicates a potential risk of electrical injury. It can also notify the user about instructions that must be strictly followed to ensure safe installation or operation of the product.
-  This symbol notifies the user about instructions that must be strictly followed to ensure proper installation or operation of the product.
-  This symbol notifies the user about complementary information or optional instructions.

## Revision history

| version number | publication date | modification   |
|----------------|------------------|--|
| 1.0            | Nov. 2023        | Initial version.   |
| 2.0            | Feb. 2024        | Updated section <a href="#">LC16D embedded Web interface</a> (p.26). |

This version of the Owner's Manual describes the LC16D firmware version 2.13.1.



Check [www.l-acoustics.com](http://www.l-acoustics.com) on a regular basis to download the latest document and software updates.

## System components

### Network audio converters

LC16D                      Network audio converter

### Software applications

LC16D embedded      LC16D embedded Web interface  
Web interface

L-Acoustics Device      L-Acoustics Device Scanner  
Scanner

USB Terminal            USB Terminal

Hive AVB Controller      Milan-compatible ATDECC (AVDECC) Controller

 Refer to the L-Acoustics Device Scanner user guide.



# Technical description

## Main features

### Front and rear panels



1. LEDs for the general status of the unit:
  - single color LED for mains presence
  - single color LED for PoE (Power over Ethernet) presence
  - dual color LED for status of the remote control
  - dual color LED for the general status of the unit
2. LEDs for clock references:
  - single color LED for internal clock
  - single color LED for word clock
  - single color LED for network (Milan-AVB clock)
  - single color LED for MADI clock
  - single color LED for AES/EBU 1 clock
3. LEDs for status/signal/clip of the AES/EBU signals:
  - 8 dual color LEDs for the AES/EBU inputs (one per pair)
  - 8 dual color LEDs for the AES/EBU outputs (one per pair)
4. LEDs for status/signal/clip of the MADI signals:
  - dual color LED for the MADI inputs
  - dual color LED for the MADI outputs

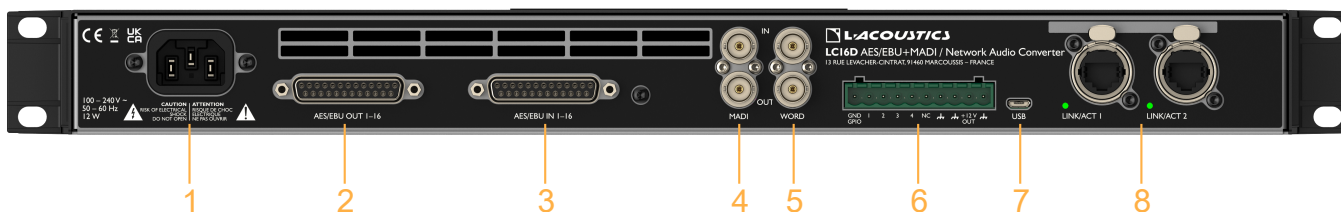

1. IEC C13 V-Lock compatible socket
2. DB25 female connector (AES59 8-way pinout annex C) for 16 AES/EBU outputs
3. DB25 female connector (AES59 8-way pinout annex C) for 16 AES/EBU inputs
4. BNC connector for MADI inputs and BNC connector for MADI outputs (75  $\Omega$  terminated)
5. BNC connector for Word clock input and BNC connector for Word clock output (75  $\Omega$  terminated)
6. 10-point terminal block General Purpose I/O (GPIO)
7. Micro USB service port
8. 2 x 1 Gb/s Ethernet etherCON I/Os for Milan-AVB I/O, network I/O, and PoE (Power over Ethernet) inputs

## Power supply

LC16D power supply offers three redundant possibilities.

LC16D is equipped with a universal Switched Mode Power Supply (SMPS) suitable for mains from 100 V AC - 240 V AC ( $\pm 10\%$ ), 50 Hz - 60 Hz.

LC16D is a Class 3 Powered Device (PD) featuring seamless power redundancy between the mains input and PoE (Power over Ethernet). In case of failure of the mains power supply, a third-party Power Sourcing Equipment (PSE) can power LC16D through either of the 1 Gb/s Ethernet ports (PoE1 and PoE2). LC16D is compatible with any IEEE 802.3at-2009 PSE.

Refer to section [Installation](#) (p.13) for detailed operating instructions.

## Signal processing

---

### Signal inputs and outputs

#### Milan-AVB

LC16D can operate in normal network mode or in redundant network mode. In both modes, 16 Milan-AVB input streams of up to 8 channels each can be connected to LC16D.

Input channels can be freely assigned to the 16 Milan-AVB output streams through a flexible matrix in the LC16D embedded Web interface.

Each Ethernet port uses a high speed data transfer protocol up to 1 Gb/s and supports the AAF PCM32 stream format with stream frequencies at 48 kHz when the device is operating at 48 kHz or 96 kHz when the device is operating at 96 kHz.

#### AES/EBU (AES3)

LC16D can be fed with up to 16 AES/EBU (AES3) digital audio signals (transported in pairs) using the **AES/EBU INPUTS 1-16** DB25 female connector. There is no latency compensation and no bypass/link. The input signals can be transmitted to the Milan-AVB output streams.

Each input signal has integrated ASRC (Asynchronous Sample Rate Converter) supporting a wide range of input formats (44.1 kHz to 192 kHz). The ASRC converts the signals to the rate selected for LC16D (48 kHz or 96 kHz). The ASRC can be disabled individually for each AES/EBU input.

LC16D can send up to 16 AES/EBU (AES3) digital audio signals (transported in pairs) coming from the Milan-AVB input streams using the **AES/EBU OUTPUTS 1-16** DB25 female connector. There is no latency compensation.

#### MADI (AES10-2003)

LC16D can be fed with up to 64 AES10 digital audio signals (at 48 kHz) or 32 AES10 digital audio signals (at 96 kHz) using the **MADI IN** BNC connector. The input signals can be transmitted to the Milan-AVB output streams.

LC16D can send up to 64 AES10 digital audio signals (at 48 kHz) or 32 AES10 digital audio signals (at 96 kHz) coming from the Milan-AVB input streams using the **MADI OUT** BNC connector.

## Clocking

LC16D synchronizes its media clock according to the selection done by the user.

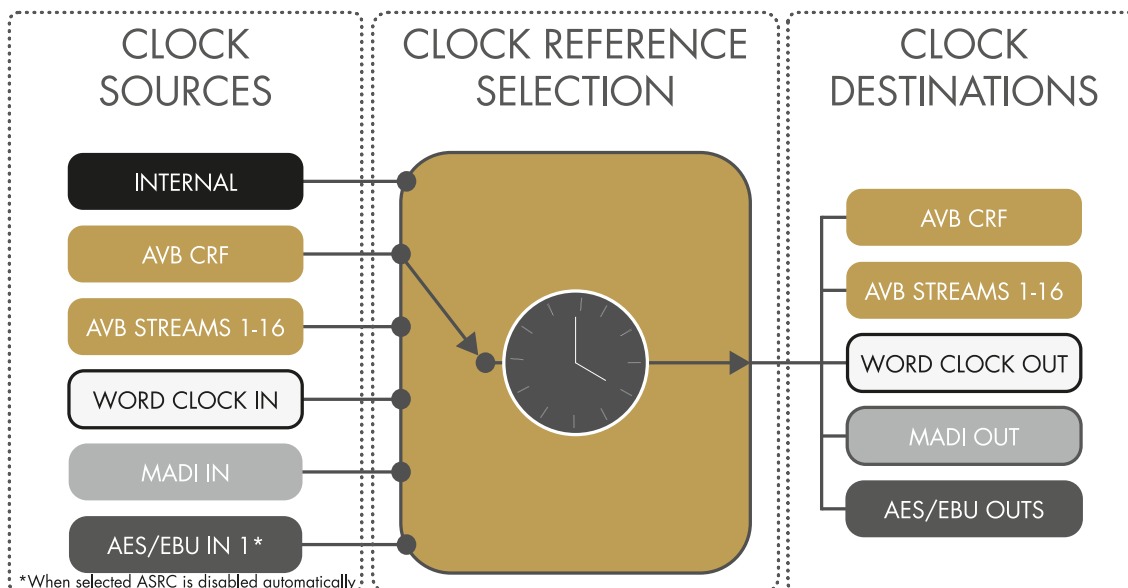

## Mapping

LC16D has a default mapping of the inputs and outputs that can be modified using the LC16D embedded Web interface. The same Milan-AVB input streams can be used several times in the mapping.

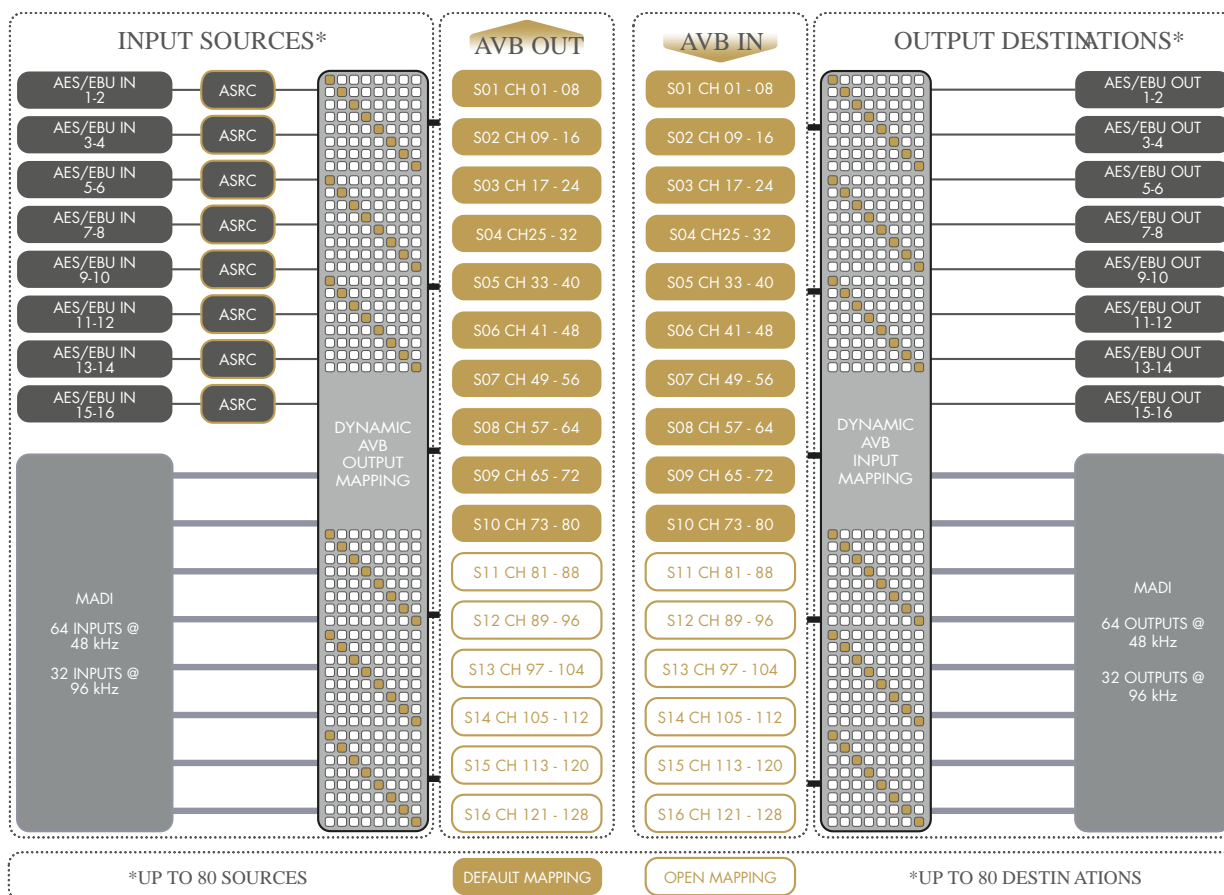

Mapping is possible from the Milan-AVB inputs to the AES/EBU and MADI outputs, and from the AES/EBU and MADI inputs to the Milan-AVB outputs. Direct mapping between Milan-AVB inputs and outputs is not possible, neither is it possible to map between AES/EBU and MADI.

LC16D does not feature any DSP and as such, cannot be used to apply EQ, gain, delay, or mute functionalities.

Use an AVDECC Controller (such as **Hive**) to connect the Milan-AVB input streams to LC16D.

## Monitoring and control

### User interface

The LED display on the front panel provides real-time monitoring functionalities:



- General status of the unit:
  - mains presence
  - PoE (Power over Ethernet) presence
  - status of the remote control
  - general status of the unit
- Clock references:
  - internal clock
  - word clock
  - network (Milan-AVB clock)
  - MADI clock
  - AES/EBU 1 clock
- Status/signal/clip of the inputs:
  - AES/EBU inputs (one per pair)
  - MADI inputs
- Status/signal/clip of the outputs:
  - AES/EBU outputs (one per pair)
  - MADI outputs

Refer to section [Operation](#) (p.21) for detailed operating instructions.

### Remote control

With its factory default settings, LC16D can be used out of the box to convert MADI and AES/EBU formats to Milan-AVB streams ready to be connected to AVB-capable devices.

The IP settings, Milan-AVB mapping, and the GPIO configuration can be edited from the **LC16D embedded Web interface**. Use an AVDECC Controller (such as **Hive**) to connect the Milan-AVB input streams to LC16D.

Once LC16D is configured, there is no need to continue remote control: it will continue to function. After a reboot or being turned off and on again, LC16D continues to apply the last used configuration.

Refer to section [Operation](#) (p.21) for detailed operating instructions.

### LC16D embedded Web interface

LC16D incorporates an embedded Web interface for remote control and monitoring which can be accessed by any device with a Web browser and network connection.

To connect LC16D and the control computer, use either industry standard CAT5e U/FTP cables (or cables of higher categories) fitted with RJ45 connectors, or a micro USB cable.

The 10-point terminal block General Purpose I/O (GPIO) can be configured to store and recall up to 10 user configurations. Refer to [General Purpose I/O \(GPIO\)](#) (p.14).

### USB Terminal

USB Terminal is an interface available on the L-Acoustics website. To connect LC16D and the control computer, use a micro USB cable.

Use USB Terminal to connect to devices and change their IP settings or reset them to factory settings.

## L-Acoustics Device Scanner

L-Acoustics Device Scanner is an application available on the L-Acoustics website. To connect LC16D and the control computer, use industry standard CAT5e U/FTP cables (or cables of higher categories) fitted with RJ45 connectors.

Use L-Acoustics Device Scanner to connect to devices even if their IP addresses are unknown, and:

- Solve IP address conflict between devices.
- Update the firmware.
- Identify, reboot, configure a password.
- Retrieve the logs, find the MAC Address and Serial Number.

Refer to the **L-Acoustics Device Scanner Technical Bulletin** for more information.

## Installation

### Mounting

LC16D is one rack units high (1U) and can be mounted in an EIA-standard 19" rack using the four points on the front panel. Use the fixing material provided by the rack manufacturer to mount the device to the rack front rails.

#### LC16D dimensions

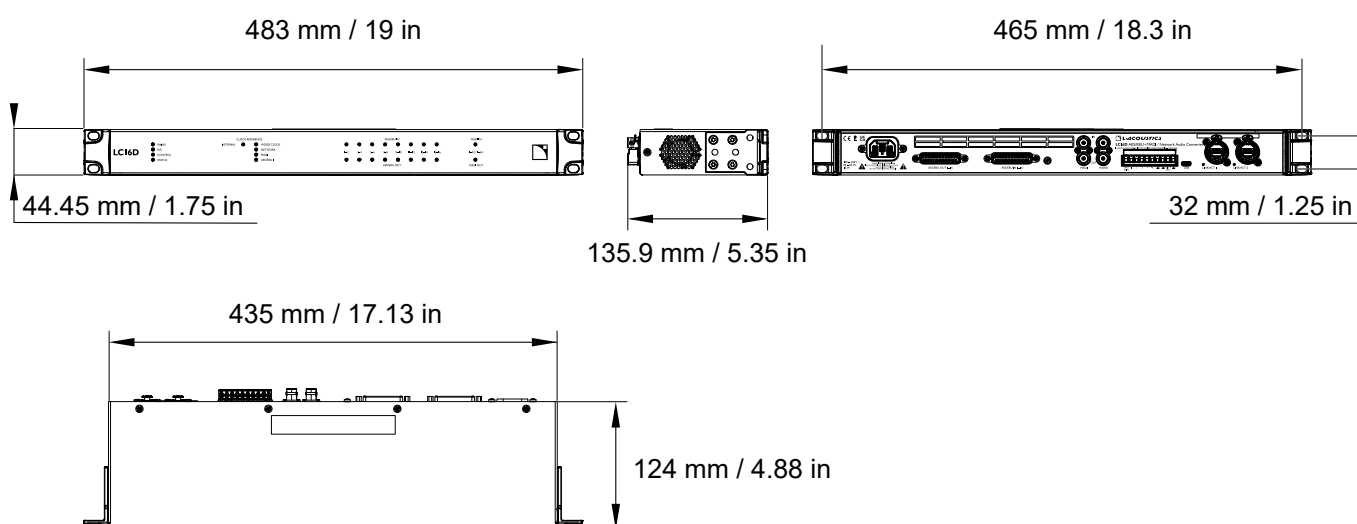

**!** LC16D is not compatible with L-CASE II.

### Ventilation

LC16D is equipped with a fan and one grill on each side to ventilate the device.

**!** **Do not block the side ventilation grills.** Install LC16D with the side panels at a minimum distance of 5 cm / 1.9 in from any external object or structure. When rack-mounted, the same distance must be guaranteed on both sides of the rack: make sure airflow is not reduced.

## General Purpose I/O (GPIO)

LC16D features a 10-point terminal block General Purpose I/O (GPIO) connector.

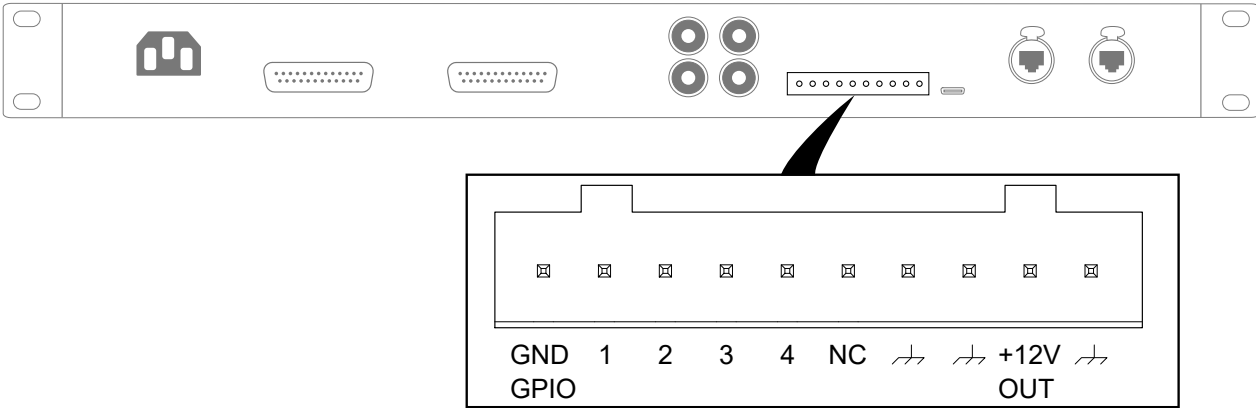

|          |  |
|----------|--|
| GND GPIO | ground                                       |
| 1        | input or output                              |
| 2        |  |
| 3        |  |
| 4        |  |
| NC       | not connected                                |
| ⎓        | chassis ground                               |
| ⎓        | chassis ground                               |
| +12V OUT | for powering a contact relay (45 mA maximum) |
| ⎓        | chassis ground                               |

GPIO can be configured using the LC16D embedded Web interface. For more information, refer to [Operation](#) (p.21).

## Power over Ethernet

LC16D is a Class 3 Powered Device (PD) featuring seamless power redundancy between the mains input and PoE (Power over Ethernet). In case of failure of the mains power supply, a third-party Power Sourcing Equipment (PSE) can power LC16D through either of the 1 Gb/s Ethernet ports (PoE1 and PoE2). LC16D is compatible with any IEEE 802.3at-2009 PSE.

When LC16D is connected to three power supplies (mains and two PSEs), it is powered by the mains power supply in priority. In case of failure of the mains power supply, LC16D is powered through the first PoE1 (second priority after the mains). In case of a failure of the PSE connected to PoE1 during a failure of the mains power supply, LC16D is powered through PoE2 (third priority). LC16D automatically switches back to PoE1 or the mains as available.

The PSE can be a PoE injector, or a PoE switch. PoE switches should be AVB-capable switches if LC16D is used in an Milan-AVB network.

Use CAT6A U/FTP patch cables (straight-through), AWG24, 50 m / 164 ft min to 100 m / 328 ft max.

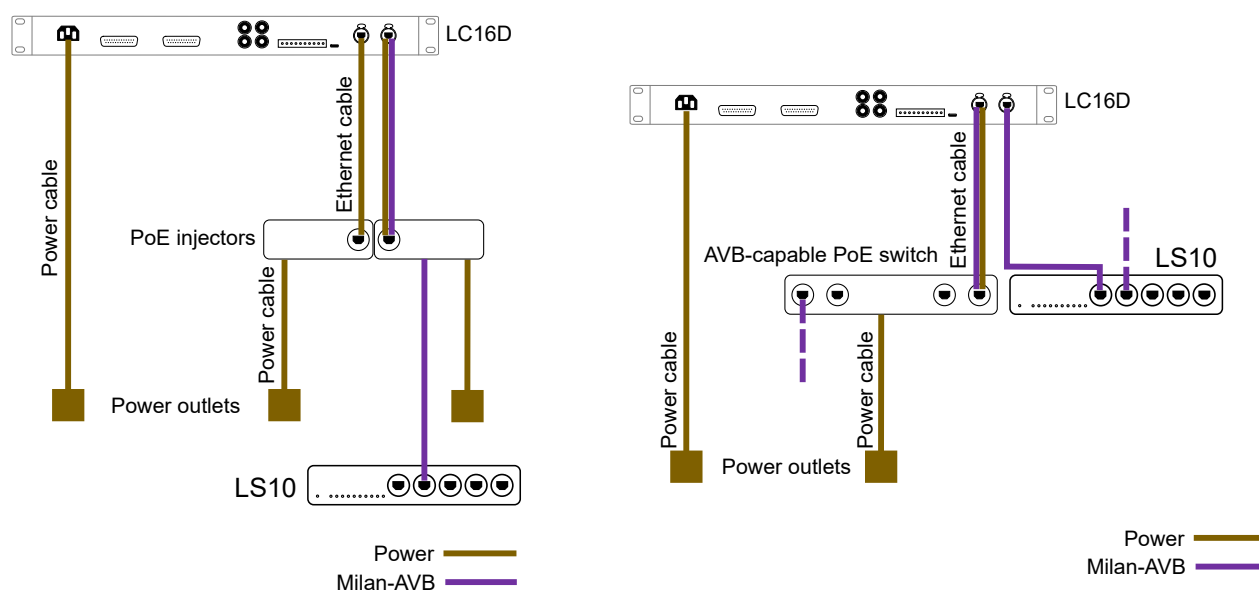

**With two PoE injectors and LS10**

**With an AVB-capable PoE switch and LS10**

L-Acoustics LS10 is an AVB-capable switch but is not a PSE device. Refer to the **LS10 Owner's Manual**.

## Connecting to AC mains

### Electrical specifications

#### AC mains specifications



#### Verify the electrical conformity and compatibility of the mains supply.

Only connect the product to an AC power outlet rated 100-240 V, 50-60 Hz.

The product draws 8 W (typical).

**WARNING:** The product is of Class 1 construction and shall be connected to a mains socket outlet with a Protective Earth connection.

#### Three-phase circuit



#### When the product is used in a three-phase circuit, verify the electrical conformity and compatibility of the three-phase circuit.

Verify that the three phases work, and balance the loads between the three phases.

Verify that the neutral and earth work.

Never try to emulate a 230 V circuit connecting an apparatus to two live wires of a 120 V three-phase circuit.

Never try to emulate a 200 V circuit connecting an apparatus to two live wires of a 100 V three-phase circuit.

## Power cord

The removable power cord is fitted with a V-Lock compatible IEC connector at one end, and a country-specific plug at the other end.

| type | plug                                     | cable ratings | live  | neutral | ground       |
|------|--|---------------|-------|---------|--------------|
| CE   | CEE7/VII, earthed                        | 10 A / 250 V  | brown | blue    | green/yellow |
| CN   | GB 2099, earthed                         |               |       |         |              |
| INT  | bare ends (local powerplug to be fitted) |               |       |         |              |
| US   | NEMA 5-15, earthed                       | 10 A / 125 V  | black | white   | green        |



Strictly apply the specific safety regulations of the country of use.

Do not defeat the ground connection of the supplied power cord using an adaptor or any other method.

A suitable plug must be wired to the INT power cord.

If the power plug does not match the local power outlet, have a qualified electrician wire a suitable plug.

## Plugging LC16D

How to plug LC16D to the AC mains.

### Procedure

- First, connect the IEC connector to the LC16D IEC C13 socket.



**Make sure the cable is properly locked.**



- Then, connect the power plug to the mains socket.  
LC16D features a power LED. LC16D is operational in less than 8 seconds.  
To power off LC16D, unplug the power cord from the mains socket.

## Power consumption

LC16D power requirement is 12 W maximum.

## Audio and network cabling

### Connectors

The rear panel of LC16D features connectors for audio and network cabling:

1. For the connection of the digital AES/EBU audio sources inputs and outputs.
2. For the connection of the MADI AES10-2003 audio sources inputs and outputs, and input and output clocks.
3. For the connection of the Milan-AVB network, and to be remotely controlled through the LC16D embedded Web interface.

### LC16D audio and network connection panels

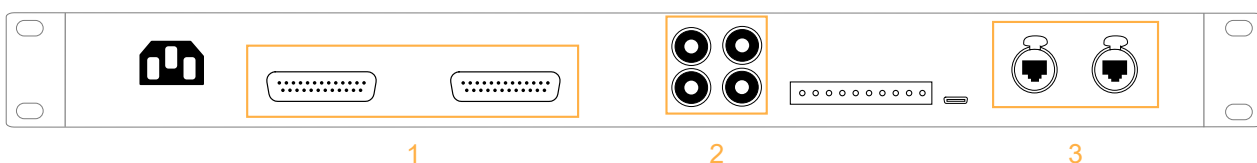



## AES/EBU audio

Use the two DB25 female connectors for AES/EBU signal cabling.

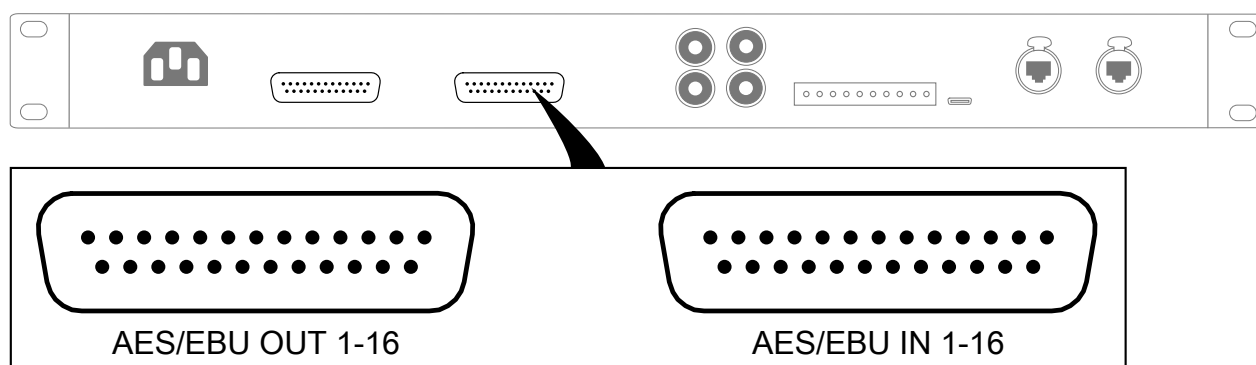

The connectors are wired according to the AES59 8-way pinout annex C standard.

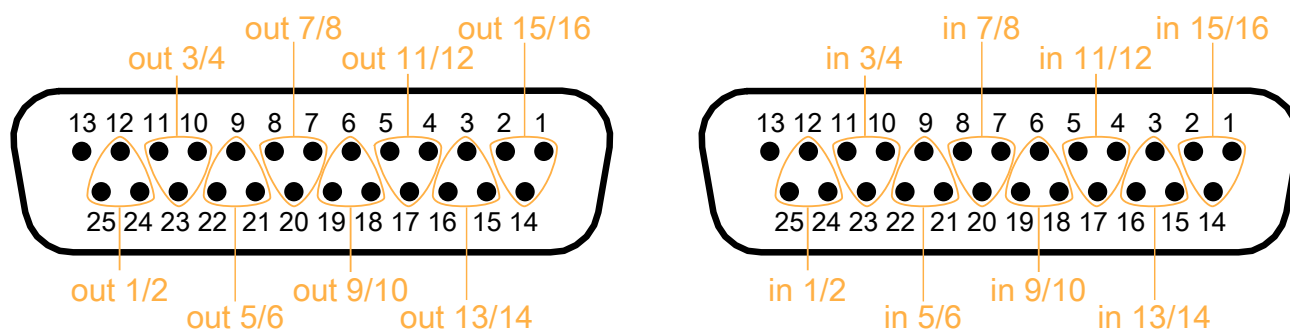

| DB25 female connectors |              |        |            |        |              |        |              |
|------------------------|--------------|--------|------------|--------|--------------|--------|--------------|
| Pin 1                  | 15/16 +      | Pin 7  | 7/8 +      | Pin 14 | 15/16 -      | Pin 20 | 7/8 -        |
| Pin 2                  | 15/16 shield | Pin 8  | 7/8 shield | Pin 15 | 13/14 +      | Pin 21 | 5/6 +        |
| Pin 3                  | 13/14 -      | Pin 9  | 5/6 -      | Pin 16 | 13/14 shield | Pin 22 | 5/6 shield   |
| Pin 4                  | 11/12 +      | Pin 10 | 3/4 +      | Pin 17 | 11/12 -      | Pin 23 | 3/4 -        |
| Pin 5                  | 11/12 shield | Pin 11 | 3/4 shield | Pin 18 | 9/10 +       | Pin 24 | in/out 1/2 + |
| Pin 6                  | 9/10 -       | Pin 12 | 1/2 -      | Pin 19 | 9/10 shield  | Pin 25 | 1/2 shield   |
| Pin 13                 | not used     |        |            |        |              |        |              |

**AES/EBU IN 1-16** can receive up to 16 AES/EBU digital audio signals (transported in pairs). The default mapping is to Milan-AVB output streams 1 and 2.

**AES/EBU OUT 1-16** can transmit up to 16 AES/EBU digital audio signals (transported in pairs). The default mapping is from input streams 1 and 2.

## MADI audio

Use the two **MADI** BNC connectors for AES10-2003 signal cabling.

Both connectors are 75 Ω terminated.

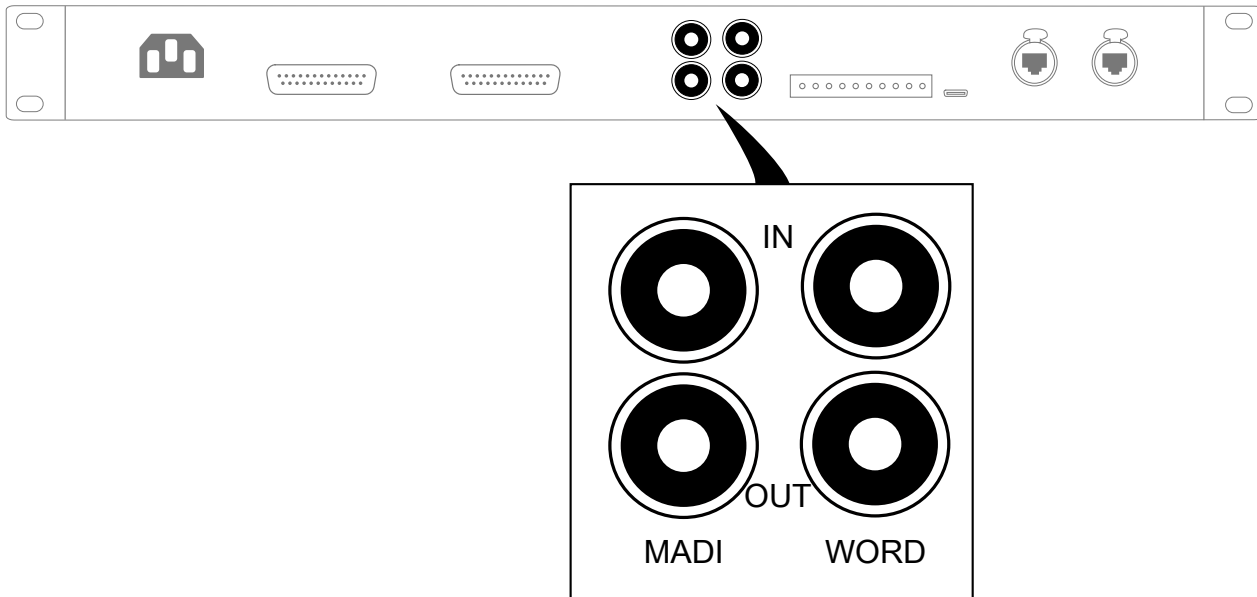

**MADI IN** can receive up to 64 AES10 digital audio signals at 48 kHz or 32 AES10 digital audio signals at 96 kHz. There is no sample rate conversion. The default mapping is to output streams 3 to 10 (at 48 kHz) or to output streams 3 to 6 (at 96 kHz).

**MADI OUT** can transmit up to 64 AES10 digital audio signals at 48 kHz or 32 AES10 digital audio signals at 96 kHz. There is no sample rate conversion. The default mapping is from input streams 3 to 10 (at 48 kHz) or from input streams 3 to 6 (at 96 kHz).

## Word clock

Use the two **WORD** BNC connectors for word clock cabling.

Both connectors are 75 Ω terminated.

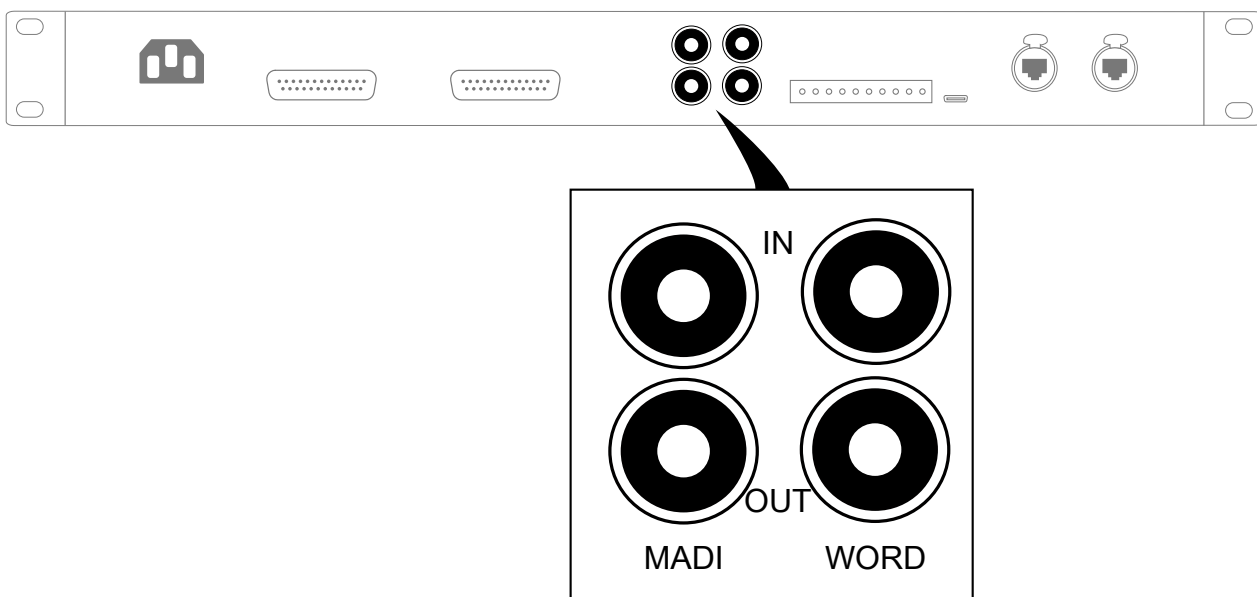

The supported input frequency is 48 kHz or 96 kHz. **WORD IN** accepts input levels from 1 V<sub>pp</sub> to 5 V<sub>pp</sub>, and is protected from overvoltage. **WORD OUT** output level is 5 V<sub>pp</sub> into open load.

## Milan-AVB

Use the two etherCON connectors for the remote control of LC16D using the LC16D embedded Web interface and an AVDECC Controller (like **Hive**). The etherCON connectors are AVB-capable. Real-time audio traffic and control traffic are automatically managed by Milan-AVB on the same network.

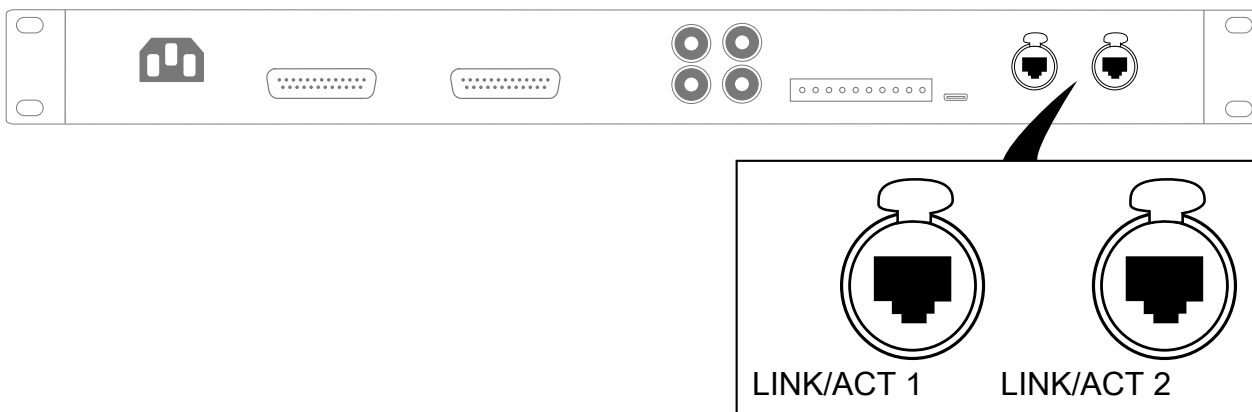

In normal network mode, the two etherCON connectors are part of an internal Milan-AVB switch.

In redundancy mode, the two etherCON connectors are independent. The LINK/ACT 1 connector is used for the primary network, and the LINK/ACT 2 connector is used for the secondary network.

LC16D can receive and send up to 16 streams in normal and in redundant mode, with up to 8 channels per stream, at 48 kHz or 96 kHz (depending on the unit setting).



**Do not create loops in the network setup.**



**In daisy-chain networks, always place LA4X with hardware version\* ID1, ID2 or ID3, LA4, and LA8 after any other type of amplified controller.**

These amplified controllers are equipped with former generation 100 Mb/s Ethernet ports that cannot communicate with Ethernet ports of different capabilities, creating detection issues in LA Network Manager.

\*The LA4X hardware version is visible in the MONITORING & INFO menu (HARDWARE INFO section).

## Cabling examples

### ***Festivals - LC16D as an AES/EBU to Milan-AVB converter***

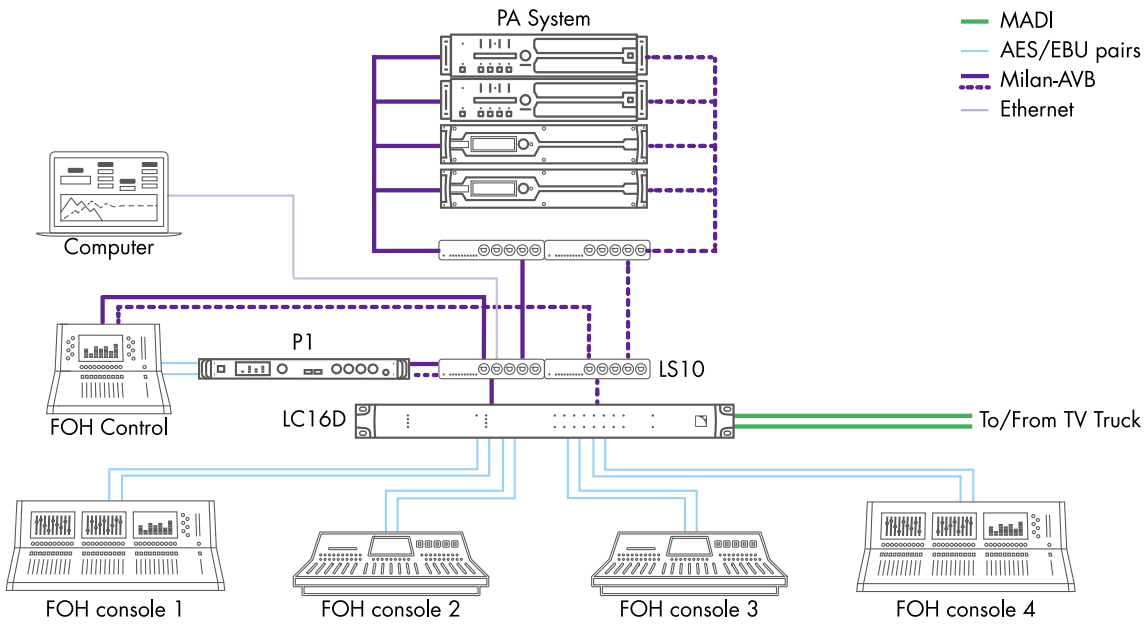

### ***L-ISA Immersive events - LC16D as a Milan-AVB to AES/EBU converter for the fallback system***

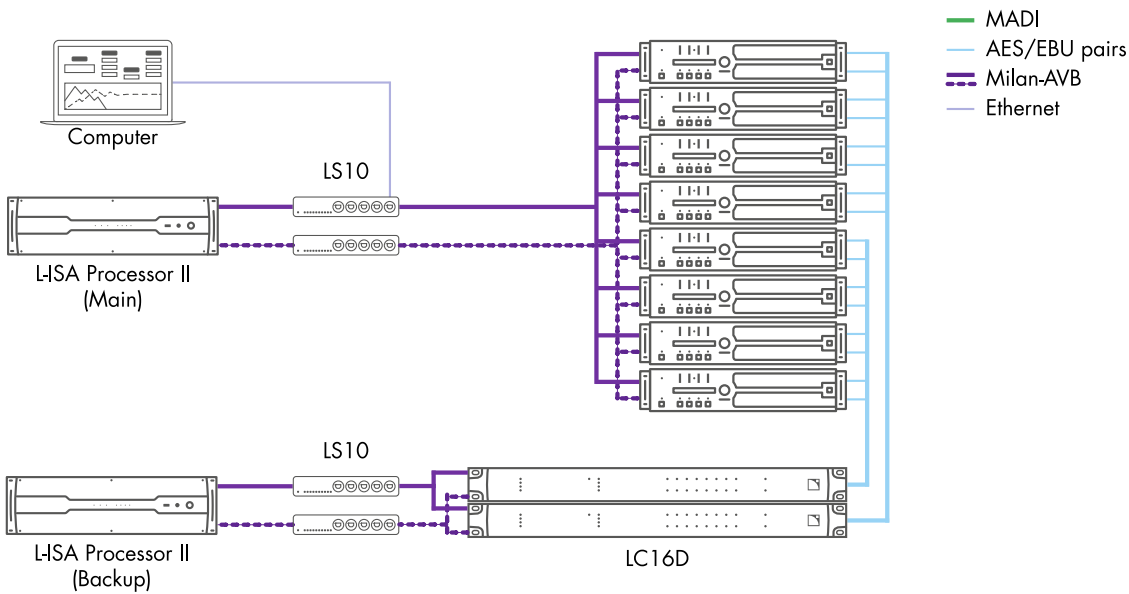

# Operation

## Powering on/off

---

LC16D turns on immediately when plugged, and turns off immediately when unplugged (no on/off switch), refer to [Plugging LC16D](#) (p.16).

During booting, all LEDs light up briefly in green or orange.

## Interpreting the front panel LEDs

---

### MAINS

The **MAINS** LED displays the status of the mains input.

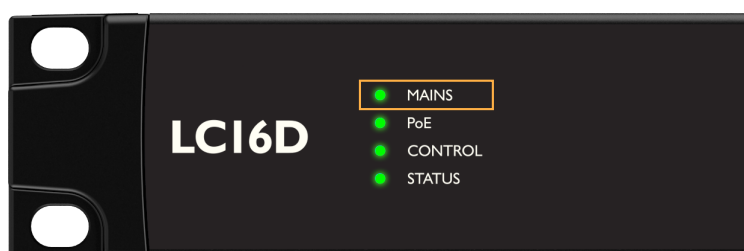

- Green: Mains power is available.
- Off: Mains power is not available.

### PoE

The **PoE** LED displays the status of the PoE inputs.



- Green: At least one of the ports is connected to a Power over the Ethernet supply.
- Off: None of the ports are connected to a Power over the Ethernet supply.

Refer to [Power over Ethernet](#) (p.15) for more information.

## CONTROL

The **CONTROL** LED on the front panel displays the status of the remote control of LC16D.

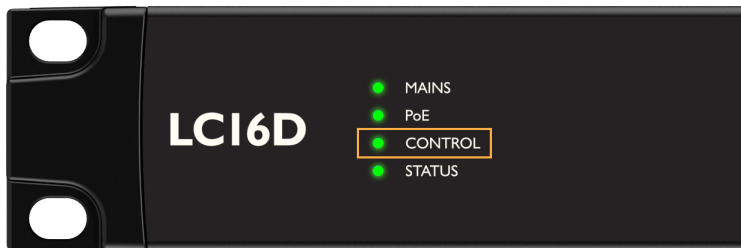

- Green: LC16D is remotely controlled through the LC16D embedded Web interface.
- Orange: LC16D is remotely controlled by a third-party software.
- Off: No software controls LC16D.

## STATUS

The **STATUS** LED on the front panel displays the status of LC16D.

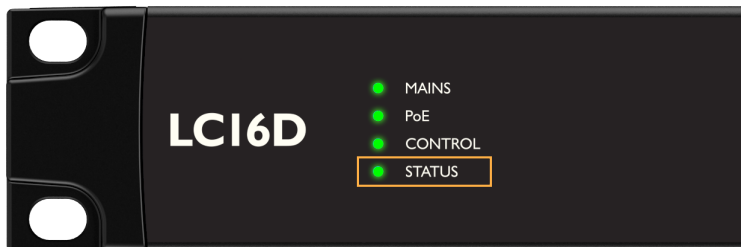

- Green: LC16D operates normally.
- Red (blinking): a fault is detected in LC16D circuitry, and a protection system is active.

## CLOCK REFERENCE

The five **CLOCK REFERENCE** LEDs on the front panel display the status of the selected clock reference.



- **INTERNAL:**
  - Green: The internal clock reference is selected.
  - Off: Another clock is selected.
- **WORD CLOCK:**
  - Green (continuous): The word clock is selected and locked.
  - Green (blinking): The word clock is selected and unlocked.
  - Off: Another clock is selected.
- **NETWORK:**
  - Green (continuous): One Milan-AVB stream is selected as reference clock and locked.
  - Green (blinking): One Milan-AVB stream is selected as reference clock and unlocked.
  - Off: another clock is selected.
- **MADI:**
  - Green (continuous): The MADI input is selected and locked.
  - Green (blinking): The MADI input is selected and unlocked.
  - Off: another clock is selected.
- **AES/EBU 1:**
  - Green (continuous): The AES/EBU 1 input is selected and locked.
  - Green (blinking): The AES/EBU 1 input is selected and unlocked.
  - Off: Another clock is selected.

## AES/EBU IN

The eight **AES/EBU IN** LEDs on the front panel display the status of the 16 AES/EBU inputs (one LED per pair of inputs).

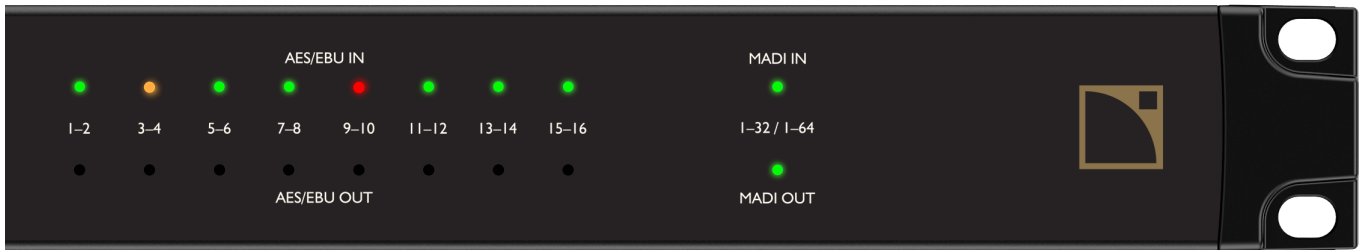

|        |            |  |
|--------|------------|--|
| Red    | Continuous | The highest level of the channel pair reaches the maximum level (signal clip).   |
|        | 1 s. blink | There is an error on the channel pair (signal unlocked, etc.).   |
| Orange | Continuous | The highest level of the channel pair reaches 3 dB below the maximum level.  |
|        | 1 s. blink | Receiving AES/EBU signals but sampling rate is wrong, or AES/EBU source is not synchronized with the selected clock reference. |
| Green  | High       | The highest level of the channel pair reaches 20 dB below the maximum level.   |
|        | Low        | The highest level of the channel pair reaches 60 dB below the maximum level.   |
| Off    |            | Not receiving AES/EBU signals, or the highest level of the channel pair is more than 60 dB below the maximum level.            |

## AES/EBU OUT

The eight **AES/EBU OUT** LEDs on the front panel display the status of the 16 AES/EBU outputs (one LED per pair of outputs).

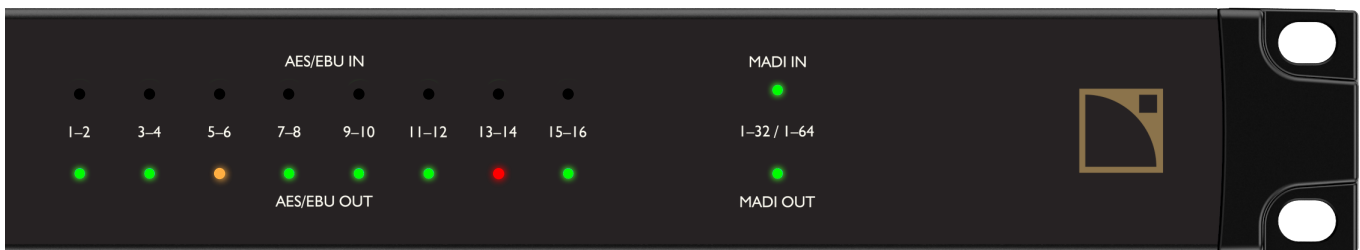

|        |      |   |
|--------|------|---|
| Red    |      | The output level of the channel pair reaches the maximum level (signal clip).     |
| Orange |      | The highest level of the channel pair reaches 3 dB below the maximum level.       |
| Green  | High | The highest level of the channel pair reaches 20 dB below the maximum level.      |
|        | Low  | The highest level of the channel pair reaches 60 dB below the maximum level.      |
| Off    |      | The highest level of the channel pair is more than 60 dB below the maximum level. |



## MADI IN

The **MADI IN** LED on the front panel displays the status of the 32 (at 48 kHz) or 64 (at 96 kHz) MADI inputs.



|        |            |  |
|--------|------------|--|
| Red    | Continuous | The highest level among all MADI inputs reaches the maximum level (signal clip).   |
|        | 1 s. blink | There is an error on the MADI input (signal unlocked, or the selected system clock frequency does not match the MADI frequency). |
| Orange | Continuous | The highest level among all MADI inputs reaches 3 dB below the maximum level.  |
|        | 1 s. blink | Receiving MADI signals but sampling rate is wrong, or MADI source is not synchronized with the selected clock reference.         |
| Green  | High       | The highest level among all MADI inputs reaches 20 dB below the maximum level.   |
|        | Low        | The highest level among all MADI inputs reaches 60 dB below the maximum level.   |
| Off    |            | Not receiving MADI signals, or the highest level among all MADI inputs is more than 60 dB below the maximum level.               |

## MADI OUT

The **MADI OUT** LED on the front panel displays the status of the 32 (at 48 kHz) or 64 (at 96 kHz) MADI outputs.

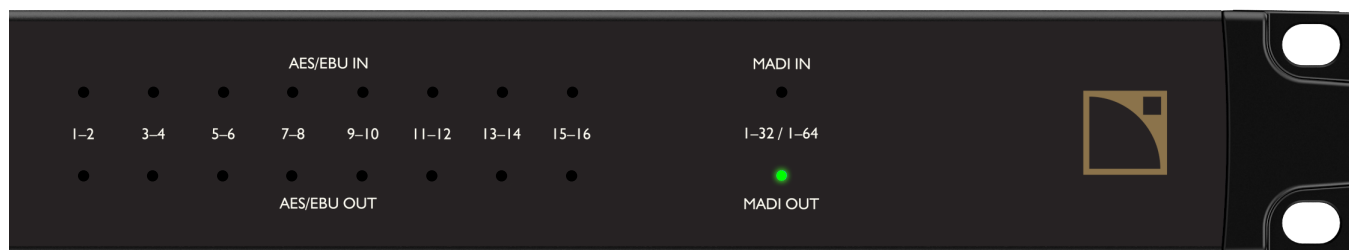

|        |      |  |
|--------|------|--|
| Red    |      | The highest level among all MADI outputs reaches the maximum level (signal clip).    |
| Orange |      | The highest level among all MADI outputs reaches 3 dB below the maximum level.       |
| Green  | High | The highest level among all MADI outputs reaches 20 dB below the maximum level.      |
|        | Low  | The highest level among all MADI outputs reaches 60 dB below the maximum level.      |
| Off    |      | The highest level among all MADI outputs is more than 60 dB below the maximum level. |

## LC16D embedded Web interface

Connect LC16D to a control computer using an Ethernet cable or a micro USB cable.

Open a Web browser and enter the IP address of LC16D to open the LC16D embedded Web interface.

### Top bar

LC16D embedded Web interface displays a top bar with configuration tools and general status.

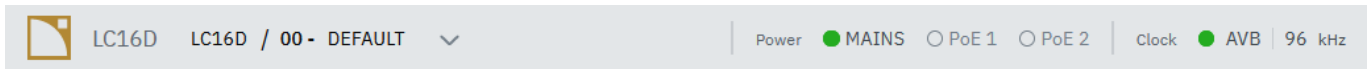

### Name

An LC16D can be given a name to identify it. Giving a name can help distinguish different devices in the same system, as the name appears in the tabs of the Web browser used to display the LC16D embedded Web interfaces, as well as in L-Acoustics Device Scanner and Hive or other AVDECC Controllers.

To edit, click the field and enter the name.

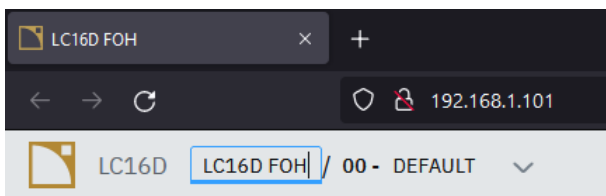

### Audio configurations

The parameters stored and loaded as part of an LC16D audio configuration are:

- The selected clock reference.
- The selected ASRC settings.
- The selected AVB input and output mappings.

To edit, click the field and enter the configuration name.

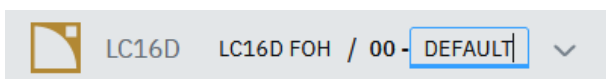

Use the menu to manage the configurations.

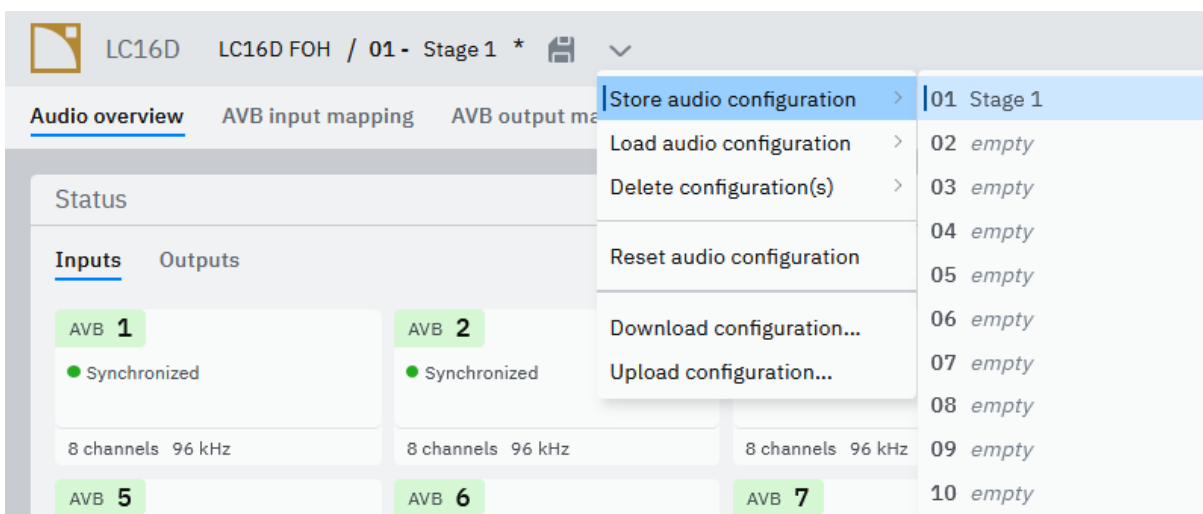

- **Store audio configuration:** Save the current audio configuration into one of the 10 slots available in the LC16D memory. Once an audio configuration is stored, unsaved changes are notified using a star sign, and a save button is displayed.

- **Load audio configuration:** Load the audio configuration saved into one of the 10 slots available in the LC16D memory.
- **Delete audio configuration:** Delete one or all of the 10 audio configurations saved into the slots of the LC16D memory.
- **Reset audio configuration:** Reset the current audio configuration to the default.
- **Download audio configuration:** Download a \*.lcfg file of the current audio configuration.
- **Upload configuration:** Upload a local \*.lcfg file to LC16D.

## General status

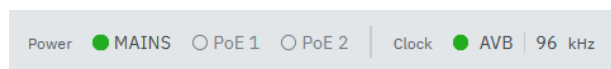

The general status includes:

- The power presence on mains, PoE 1, and PoE 2.  
For more information, refer to [MAINS](#) (p.21) and [PoE](#) (p.21).
- The status (green: locked, red: unlocked) and the source of the clock reference.
- The mode at which LC16D is operating: 48 kHz or 96 kHz.

## Audio overview

The **Audio overview** tab gives access to panels to monitor the input/output statuses, configure the clock, and configure the AES/EBU ASRC settings.

### Status

The **Status** panel gives access to two tabs, **Inputs** and **Outputs**, displaying the statuses on tiles:

- 16 tiles for the 16 Milan-AVB inputs/outputs
- 8 tiles for the 8 AES/EBU inputs/outputs
- 4 to 16 tiles for the 32 to 64 MADI inputs/outputs (8 inputs/outputs per tile)

Selecting a tile opens a side panel with an extended view.

The screenshot shows the 'Status' panel with two tabs: 'Inputs' and 'Outputs'. The 'Inputs' tab is active, displaying a grid of 16 AVB tiles (AVB 1 to AVB 16). Each tile shows a green dot indicating 'Synchronized' status and '8 ch - 96 kHz' configuration. The AVB 1 tile is highlighted with a blue border. To the right, a side panel for AVB 1 is open, showing a close button (X) and the following details:

- Status:** Synchronized
- Info:**
  - Number of channels: 8
  - Sampling rate: 96 kHz

## Information on the tiles and extended views

|                          | status | number of channels          | sampling rate          | level meters |
|--------------------------|--------|-----------------------------|------------------------|--------------|
| <b>Milan-AVB inputs</b>  | yes    | expected number of channels | expected sampling rate | –            |
| <b>Milan-AVB outputs</b> |        | yes                         | yes                    |              |
| <b>AES/EBU inputs</b>    | yes    | –                           | yes                    | yes          |
| <b>AES/EBU outputs</b>   | –      |                             | –                      |              |
| <b>MADI inputs</b>       | –      | –                           | –                      | yes          |
| <b>MADI outputs</b>      |        |                             |                        |              |

### Presentation time

The extended view of the Milan-AVB outputs includes a setting for the presentation time.

The presentation time is set at 2 ms by default, for compliance with the Milan-AVB standard. It is possible to select a lower presentation time, if needed.

On 1 Gb/s AVB networks, delivery after 13 hops is no longer guaranteed when the presentation time is lower than 2 ms. For guaranteed delivery, use **Hive** after stream connection to check that the furthest listeners in the network do not report MSRP latency errors.

A presentation time of 0.5 ms can only be used with a direct Ethernet connection from LC16D to an amplified controller (with no AVB switch in between), for example when used as front-end for monitor applications.

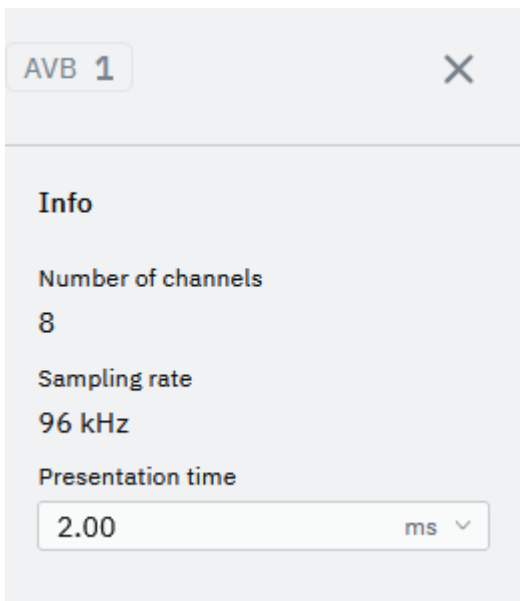

The selection of the presentation time can be unavailable if the stream is already connected or if LC16D is locked by an AVB controller (such as **Hive**).

### Idle

A tile displaying a disconnected cable means that the corresponding input or output is in idle mode.

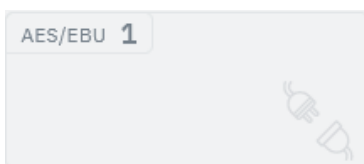

The idle mode means that the input/output is not used.

If an input/output is in use and is disconnected, an error is displayed. If the input/output is disconnected on purpose, it is possible to clear the error in the extended view to reset to the idle mode.

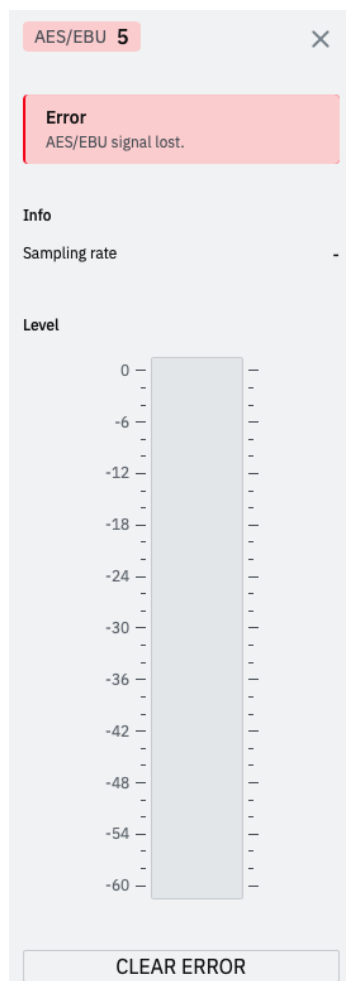

## Errors and warnings

When there is an error, the corresponding tile has orange or red highlights.

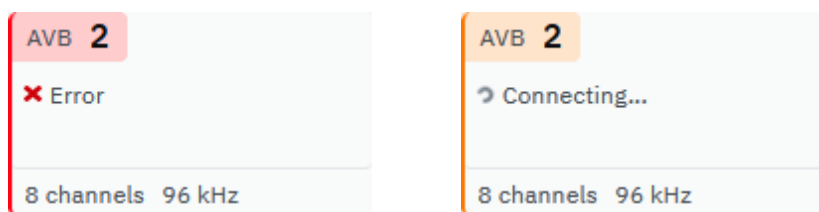

Warnings and errors can include:

- When a single stream is connected to an AVB input when LC16D is in redundant mode.
- When the connected stream is no longer received (talker is offline).
- When the connected signal does not match the expected format (sampling rate, number of channels).

## Clock

Use the **Clock** panel to set the LC16D clock reference.

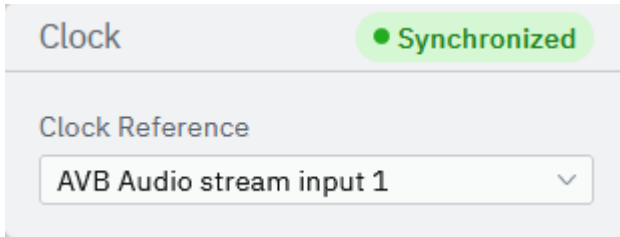

Select the clock reference:

- Internal
- Word clock
- MADI
- AES/EBU Input 1
- One of the 16 Milan-AVB input streams or the Milan-AVB CRF stream\*.

The current clock status is displayed.

Audio input sources are **not** transmitted if their sampling frequency is different from the operating sampling frequency.

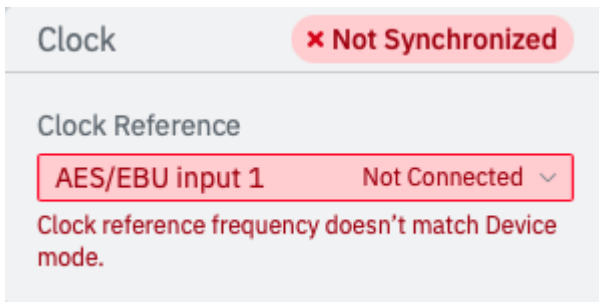

If the selected clock reference is lost, a warning is displayed and LC16D operates in "freewheel" mode. Audio at the same sampling frequency is transmitted but there can be small glitches in the audio as the phase drifts between the clocks. A valid clock reference that matches the audio signals should be selected.

If the sampling frequency matches but the phase is not locked, a warning is displayed. Audio input sources are transmitted but there can be small glitches in the audio.

The selection of the clock reference can be unavailable if LC16D is locked by an AVB controller (such as **Hive**).

\* Use an AVDECC Controller (such as **Hive**) to connect the Milan-AVB input streams to LC16D.

## ASRC

Use the **ASRC** panel to individually turn on or off the ASRC (Asynchronous Sample Rate Converter) of each AES/EBU input.

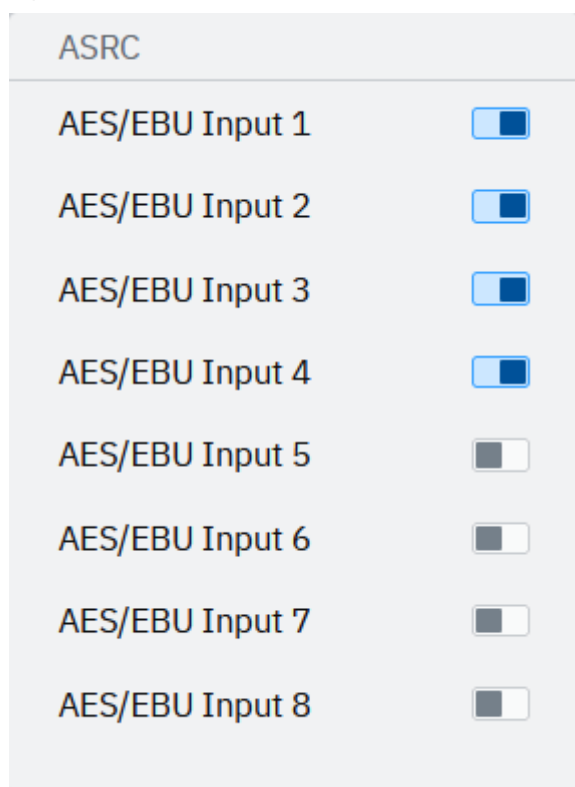

Turning off the ASRC can be used to propagate a particular clock domain from an AES/EBU input, or if all AES/EBU inputs are on the same clock.

## AVB input mapping

Use the **AVB input mapping** tab to configure the mapping of the 16 Milan-AVB input streams (on the left) to the 16 AES/EBU outputs and to the 32 or 64 MADI outputs (on the top).

Use an AVDECC Controller (such as **Hive**) to connect the Milan-AVB input streams to LC16D.

Use the arrows to collapse or expand parts of the matrix table.

Click a cell in the matrix to map a Milan-AVB input stream to an output. The cell turns blue. Click the cell again to remove the mapping. The same Milan-AVB input streams can be used several times in the mapping. The blue lines at the top of columns or the side of rows indicate the presence of an active mapping in that column/row.

There is a signal status at the top of each column:

- Green: The level reaches 60 dB below the maximum level.
- Off: Not receiving signals, or the level is more than 60 dB below the maximum level.

### Default input mapping

|  | AES/EBU outputs              |      | MADI outputs |      |       |       |       |       |       |       |
|--|------------------------------|------|--------------|------|-------|-------|-------|-------|-------|-------|
|  | 1-8                          | 9-16 | 1-8          | 9-16 | 17-24 | 25-32 | 33-40 | 41-48 | 49-56 | 57-64 |
| Milan-AVB input stream 1, channels 1-8       | x                            |      |              |      |       |       |       |       |       |       |
| Milan-AVB input stream 2, channels 1-8       |                              | x    |              |      |       |       |       |       |       |       |
| Milan-AVB input stream 3, channels 1-8       |                              |      | x            |      |       |       |       |       |       |       |
| Milan-AVB input stream 4, channels 1-8       |                              |      |              | x    |       |       |       |       |       |       |
| Milan-AVB input stream 5, channels 1-8       |                              |      |              |      | x     |       |       |       |       |       |
| Milan-AVB input stream 6, channels 1-8       |                              |      |              |      |       | x     |       |       |       |       |
| When operating at 48 KHz sampling frequency: |                              |      |              |      |       |       |       |       |       |       |
| Milan-AVB input stream 7, channels 1-8       |                              |      |              |      |       |       | x     |       |       |       |
| Milan-AVB input stream 8, channels 1-8       |                              |      |              |      |       |       |       | x     |       |       |
| Milan-AVB input stream 9, channels 1-8       |                              |      |              |      |       |       |       |       | x     |       |
| Milan-AVB input stream 10, channels 1-8      |                              |      |              |      |       |       |       |       |       | x     |
| Milan-AVB input streams 11-16                | no channel mapped by default |      |              |      |       |       |       |       |       |       |

The input mapping can be unavailable if LC16D is locked by an AVB controller (such as **Hive**).



## AVB output mapping

Use the **AVB output mapping** tab to configure the mapping of the 16 AES/EBU inputs and the 32 or 64 MADl inputs (on the top) to the 16 Milan-AVB output streams (on the right).

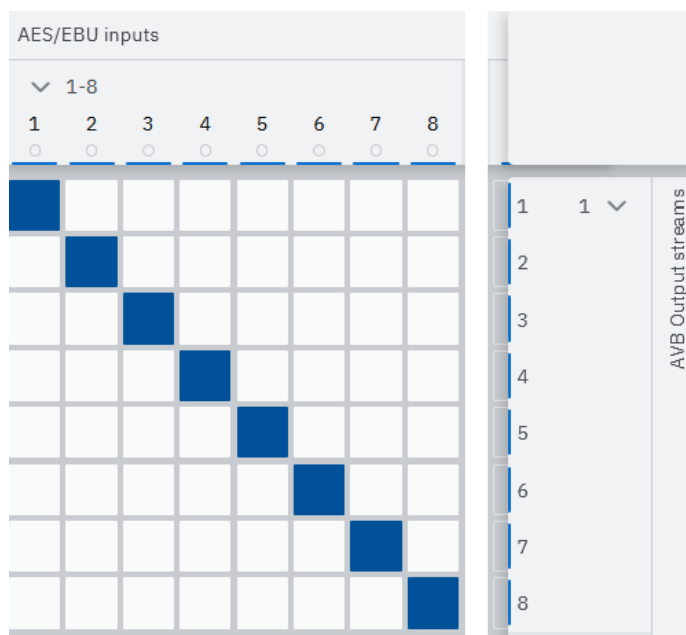

Use the arrows to collapse or expand parts of the matrix table.

Click a cell in the matrix to map a Milan-AVB input stream to an output. The cell turns blue. Click the cell again to remove the mapping. The blue lines at the top of columns or the side of rows indicate the presence of an active mapping in that column/row.

There is a signal status at the top of each column:

- Green: The level reaches 60 dB below the maximum level.
- Off: Not receiving signals, or the level is more than 60 dB below the maximum level.

### Default output mapping

| AES/EBU inputs                               |      | MADI inputs |      |       |       |       |       |       |       |  |
|--|------|-------------|------|-------|-------|-------|-------|-------|-------|--|
| 1-8  | 9-16 | 1-8         | 9-16 | 17-24 | 25-32 | 33-40 | 41-48 | 49-56 | 57-64 |  |
| x  |      |             |      |       |       |       |       |       |       | Milan-AVB output stream 1, channels 1-8  |
|  | x    |             |      |       |       |       |       |       |       | Milan-AVB output stream 2, channels 1-8  |
|  |      | x           |      |       |       |       |       |       |       | Milan-AVB output stream 3, channels 1-8  |
|  |      |             | x    |       |       |       |       |       |       | Milan-AVB output stream 4, channels 1-8  |
|  |      |             |      | x     |       |       |       |       |       | Milan-AVB output stream 5, channels 1-8  |
|  |      |             |      |       | x     |       |       |       |       | Milan-AVB output stream 6, channels 1-8  |
| When operating at 48 KHz sampling frequency: |      |             |      |       |       |       |       |       |       |  |
|  |      |             |      |       |       | x     |       |       |       | Milan-AVB output stream 7, channels 1-8  |
|  |      |             |      |       |       |       | x     |       |       | Milan-AVB output stream 8, channels 1-8  |
|  |      |             |      |       |       |       |       | x     |       | Milan-AVB output stream 9, channels 1-8  |
|  |      |             |      |       |       |       |       |       | x     | Milan-AVB output stream 10, channels 1-8 |
| no channel mapped by default                 |      |             |      |       |       |       |       |       |       | Milan-AVB output streams 11-16           |

The output mapping can be unavailable if LC16D is locked by an AVB controller (such as **Hive**).

## GPIO

Use the **GPIO** tab to configure the LC16D GPIO. Refer to [General Purpose I/O \(GPIO\)](#) (p.14) for more information on the GPIO connector.

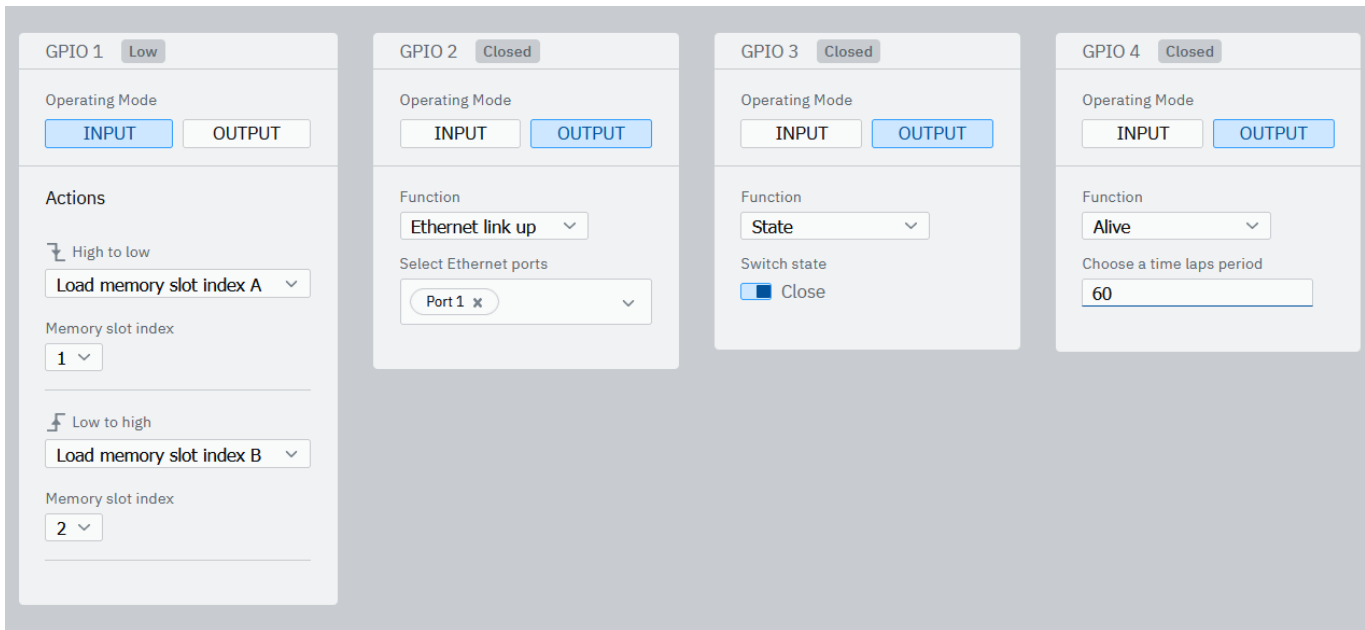

LC16D GPIO connector has four pins available either as input or output.

### Inputs

Every GPI can have two actions:

- one action when its state changes from LOW to HIGH,
- one action when its state changes from HIGH to LOW.

This allows the GPI to adapt to the type of device used for triggering the actions (push button, two-state switch, dry contact relay, etc.).

### List of actions

List of GPI actions available with firmware 2.13.1. This list may evolve in future firmware releases.

| Action name                 | Description                                       | Options                        |
|-----------------------------|---|--------------------------------|
| Choose an action            | The GPI is not used                               | N/A                            |
| Load memory slot index A    | Load the configuration in selected memory slot A. | Configuration slot A (1 to 10) |
| Load memory slot index B    | Load the configuration in selected memory slot B. | Configuration slot B (1 to 10) |
| Load next configuration     | Load the next available configuration.            | N/A                            |
| Load previous configuration | Load the previous available configuration.        | N/A                            |

### Load configuration A/B

If a configuration slot is empty when trying to load it, the command is discarded.

Each GPI has its own A and B options for configuration slot selection allowing to load up to 10 different configuration slots from the four GPI of LC16D.

### Load Next/Previous configuration

The next/previous configuration ignores empty configuration slots, and is circular (the next configuration slot after 10 is 1, and conversely). If all configuration slots are empty, the command is discarded.

## Outputs

By default, all GPO are in the OPEN state.

## List of functions

List of GPO functions available with firmware 2.13.1. This list may evolve in future firmware releases.

| Function name     | Description  | Options   |
|-------------------|--|---|
| Choose a function | The GPO is not used.   | N/A   |
| State             | Manually set the GPO state.                                  | Switch state  |
| Alive             | Periodically switch between OPEN and CLOSED states.          | Choose a time lapse period (1 to 60 seconds)  |
| Fault             | Report a selection of possible faults.                       | <ul style="list-style-type: none"> <li>Stream 1 to 16</li> <li>AES/EBU 1 to 8</li> <li>Ethernet Port 1 and 2</li> </ul> |
| Ethernet link up  | Report a failing or disconnected Ethernet network port.      | Ethernet Port 1 and 2   |
| AES/EBU locked    | Report an AES/EBU lock issue on any of the 8 AES/EBU inputs. | AES/EBU 1 to 8  |
| AVB locked        | Report an AVB lock issue on the AVB input streams.           | Stream 1 to 16  |

## Alive

The GPO state is alternating between OPEN and CLOSED states every time the time lapse period (set from 1 to 60 seconds) is elapsed.

## Fault / Ethernet link up / AES/EBU locked / AVB locked

Multiple selection is possible among the available fault options. If any of the selected options is reporting a fault, then the GPO reports a fault. A fault is reported by the GPO state OPEN. In case of no fault detected, the GPO state is CLOSED.

| GPO state | Condition   |
|-----------|---|
| OPEN      | At least one of the selected options is reporting a fault: <ul style="list-style-type: none"> <li>At least one of the selected AVB input streams is not locked (primary OR secondary), or there is no AVB input stream selected for this function.</li> <li>At least one of the selected AES/EBU inputs is not locked, or there are no AES/EBU inputs selected for this function.</li> <li>At least one of the selected Ethernet ports is DOWN, or there are no Ethernet ports selected for this function.</li> </ul> |
| CLOSED    | All the selected options are not reporting any fault: <ul style="list-style-type: none"> <li>All selected AVB input streams are locked (primary AND secondary).</li> <li>All selected AES/EBU inputs are locked.</li> <li>All selected Ethernet ports are UP.</li> </ul>  |

## Settings

The **Settings** tab gives access to panels to configure LC16D network, sampling rate, and LED brightness, and to update LC16D firmware.

### Network

Use the **Network** panel to edit the network configuration of LC16D.

The image shows two side-by-side screenshots of the 'Network' configuration panel. Both panels have a title 'Network' and a 'Mode' section with two buttons: 'NORMAL' (selected with a checkmark) and 'REDUNDANT'. Below this is an 'RSTP' section with a toggle switch that is currently turned off. The 'IP Settings' section is the focus. In the left screenshot, there is an 'EDIT' button next to the IP Settings section. In the right screenshot, the 'EDIT' button is replaced by an 'X' button and an 'APPLY' button. The IP address field is filled with '192.168.1.100', the Subnet mask field is filled with '255.255.255.0', and the Gateway field is filled with '0.0.0.0'.

### IP Settings

Click **EDIT** to configure the **IP settings** (IP address, netmask, and gateway).



After applying a change to the IP address, the Web browser is redirected to the new IP address.

An IP address is a unique identifier for a network device on a given IP network. In IPv4 networking, it is made of 4 bytes (32 bits). An IP address is composed of a subnet address and a host address. The host address serves as a unique device identifier on the subnet. The subnet mask determines how many bits define the subnet address, and how many define the host address.

By convention, the first possible number of the host address is reserved to designate the subnet, and the last number is reserved to communicate with all devices of the subnet (IP broadcast address).

The factory default IP settings of all L-Acoustics devices are:

- IP address: 192.168.1.100
- Subnet address: 192.168.1.0/24
- IP broadcast address: 192.168.1.255
- Subnet mask: 255.255.255.0

With these settings, the first three bytes of the IP address (192.168.1) define the subnet address, and the last byte is the host address (100).

In general, it is recommended to:

- Use the default subnet address and subnet mask.
- Edit the device host address to provide a unique identifier to each unit: use consecutive IP addresses starting from 192.168.1.**1** up to 192.168.1.**253**.
- Set the control computer to 192.168.1.**254**.

However, it is possible to configure other IP settings when required by network administration. Subnet mask may be defined from 255.0.0.0 to 255.255.255.0, and the IP and gateway addresses must both belong to one of the following IP ranges (standards for Private Local Area Networks):

- 10.0.0.1 to 10.255.255.254
- 100.64.0.1 to 100.127.255.254
- 172.16.0.1 to 172.31.255.254
- 169.254.0.1 to 169.254.255.254 (not recommended)
- 192.168.0.1 to 192.168.255.254

**!** **LC16D must be using the same subnet and subnet mask as the control computer and the other units in the network.**

A gateway IP address is an advanced setting reserved for specific applications such as amusement parks, campuses, and multi-room venues with a centralized third-party supervision tool (Crestron, Q-SYS, etc.). In such contexts, the supervision tool is often located in a different subnet that is interconnected with the subnets of the units. Interconnection is achieved using a gateway. The gateway address must be set on the units to enable communication with the supervision tool.

## Network mode

**!** **Risk of broadcast storm.**

To enable the redundancy mode: connect the primary network cables in a star topology, and first change the mode, then connect the secondary network cables.

To disable the redundancy mode: always disconnect the secondary network cables first, then change the mode.

**Changing network mode requires rebooting LC16D.**

Select the network mode as **NORMAL** or **REDUNDANT**.

In normal mode:

- LC16D has a single IP address.
- Either Ethernet port can be used to connect to the network.

In redundancy mode:

- LC16D has two IP addresses, one for the primary network, one for the secondary network.
- Ethernet port 1 is dedicated to the primary network, Ethernet 2 is dedicated to the secondary network.

Using the redundancy mode reduces the risk of network failure: in case of failure of the primary network, the signal of the secondary network is automatically and seamlessly picked up and used as a replacement. When the primary network is up and running again, it is automatically used again, seamlessly, with no user intervention.

After setting LC16D in redundant mode, set up the two IP addresses.

**In AVB redundant mode**, the host address is always made identical for both the Primary and the Secondary network. The subnet address of the Secondary network is that of the Primary +1. For example, with default settings:

- Primary port: 192.168.**1**.100
- Secondary port: 192.168.**2**.100

The subnet mask setting always applies to both networks. When using smaller subnet masks, the host address is also made identical. For example:

- Primary port: 172.**16**.1.100
- Secondary port: 172.**17**.1.100

The Gateway address is only available for the Primary network.

## RSTP

Enable/Disable the RSTP (Rapid Spanning Tree Protocol).

When RSTP is enabled, the protocol detects and automatically disables Ethernet ports to cut loops created by redundant links in the network, and avoid damaging broadcast storms. In case of a cable or switch failure in the network, the protocol can re-enable these ports to restore connectivity.

Enable RSTP if the LC16D is part of a network loop. Disable RSTP if there is no risk of LC16D being part of a network loop.

## Sampling rate

Use the **Sampling rate** panel to configure the LC16D sampling rate.

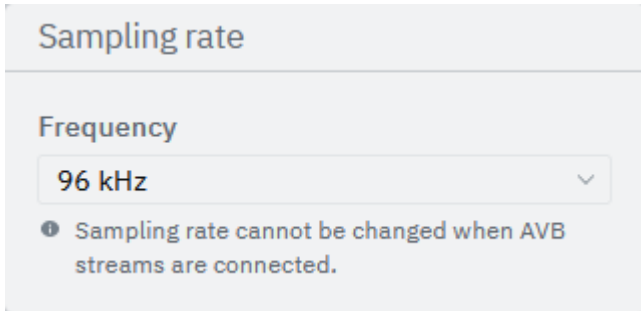

Sampling rate

Frequency

96 kHz

ⓘ Sampling rate cannot be changed when AVB streams are connected.

Select the mode at which LC16D is operating: 48 kHz or 96 kHz.

This setting impacts the frequency of the Milan-AVB streams. For this reason, it is not possible to change the clock reference when Milan-AVB streams are already connected.

The selection of the sampling rate can be unavailable if LC16D is locked by an AVB controller (such as **Hive**).

## LED brightness

The brightness of the LED can be modified to adapt to a very bright or very dark environment.

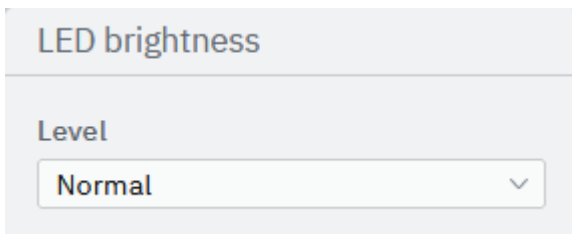

LED brightness

Level

Normal

## Firmware

Use the **Firmware** panel to check the version number of the firmware currently installed on LC16D, and update the firmware.

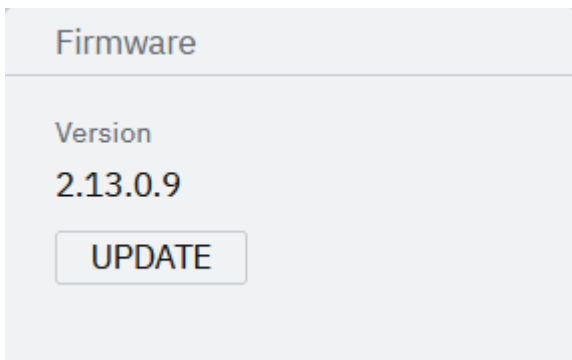

Firmware

Version

2.13.0.9

UPDATE

Click **UPDATE** to browse to the firmware file location on the control computer. The firmware update process reboots LC16D.

**! After a firmware update, clear the Web browser cache to make sure the LC16D embedded Web interface is properly refreshed.**

## **Additional actions**

Click the three dots on the right to open a menu for additional actions.

### **Reboot**

Reboot LC16D.

# Specifications

## Specifications

---

All values given in this section are typical values.

### General

#### Power supply

|                           |   |
|---------------------------|---|
| Mains rating              | 100 V AC - 240 V AC ( $\pm$ 10%), 50 Hz - 60 Hz   |
| Power consumption         | Maximum: 12 W<br>Typical/Idle: 8 W  |
| Mains inputs              | 1 IEC C13 V-Lock compatible socket  |
| PoE (Power over Ethernet) | Class 3 PoE Powered Device (PD) compatible with any IEEE 802.3at-2009 third-party Power Sourcing Equipment (PSE) using the 2 Ethernet etherCON I/Os |
| Power redundancy          | Seamless redundancy between AC mains inputs (highest priority), PoE1 (second highest priority), and PoE2  |

### Protection

|                |   |
|----------------|---|
| Cooling system | temperature controlled fan<br>low noise |
|----------------|---|

### Signal processing

#### Milan-AVB

|                       |   |
|-----------------------|---|
| Featured AVB entities | MILAN™-compatible Milan-AVB Talker and Milan-AVB Listener   |
| Standards             | Ethernet Milan-AVB IEEE 802.1BA-2011:<br>Transport: IEEE 1722-2016 (AVTP)<br>Control: IEEE 1722.1-2021 (ATDECC)<br>Timing and synchronization: IEEE 802.1AS-2011  |
| Redundancy            | RSTP (Rapid Spanning Tree Protocol)<br>MILAN seamless redundancy  |
| Input audio streams   | Number: 16 in normal mode and in redundancy mode<br>Class: A<br>Maximum network latency: 2 ms<br>Formats: AAF PCM32, up to 8 channels<br>at 48 kHz when the device is operating at 48 kHz<br>at 96 kHz when the device is operating at 96 kHz |
| Input clock stream    | 1 CRF at 48 kHz   |



|                      |  |
|----------------------|--|
| Output audio streams | Number: 16 in normal mode and in redundancy mode<br>Class: A<br>Maximum network latency (Talker presentation time offset): fixed at 2 ms<br>Formats: AAF PCM32, up to 8 channels<br>at 48 kHz when the device is operating at 48 kHz<br>at 96 kHz when the device is operating at 96 kHz |
| Output clock streams | 1 CRF at 48 kHz  |
| Media clock          | upon user selection:<br>internal clock<br>word clock<br>Milan-AVB input stream<br>MADI input<br>AES1 input   |

## AES/EBU

### Inputs

|                      |  |
|----------------------|--|
| Number of channels   | 16, with integrated ASRC   |
| Sampling rate        | 44.1 kHz to 192 kHz  |
| Latency compensation | No   |
| Bypass/Link          | No   |
| AES Input Sync       | AES/EBU 1 clock at 48 kHz / 96 kHz (ASRC can be disabled individually) |

### Outputs

|                      |                   |
|----------------------|-------------------|
| Number of channels   | 16                |
| Sampling rate        | 48 kHz and 96 kHz |
| Latency compensation | No                |

## MADI (AES10-2003)

### Inputs

|                        |                              |
|------------------------|------------------------------|
| Number of channels     | 64 at 48 kHz<br>32 at 96 kHz |
| Sample Rate Conversion | No                           |

### Outputs

|                        |                              |
|------------------------|------------------------------|
| Number of channels     | 64 at 48 kHz<br>32 at 96 kHz |
| Sample Rate Conversion | No                           |

## Word clock

|                    |  |
|--------------------|--|
| Input frequency    | 48 kHz / 96 kHz  |
| Input termination  | 75 Ω   |
| Input level        | from 1 V <sub>pp</sub> to 5 V <sub>pp</sub> input level, overvoltage protected |
| Output frequency   | 48 kHz / 96 kHz  |
| Output termination | 75 Ω   |
| Output level       | 5 V <sub>pp</sub> into open load   |

## Internal conversion latency\*

| from                            | to               | latency                 |
|---------------------------------|------------------|-------------------------|
| AES/EBU (ASRC disabled) or MADI | Milan-AVB        | 0.2 ms                  |
| AES/EBU 96 kHz (ASRC enabled)   | Milan-AVB 96 kHz | 0.3 ms (minimum)        |
| AES/EBU 96 kHz (ASRC enabled)   | Milan-AVB 48 kHz | 0.4 ms (maximum)        |
| Milan-AVB                       | AES/EBU or MADI  | negligible (one sample) |

\* For global chain latency, add the presentation time of the AVB stream.

## Remote control

|                                     |   |
|-------------------------------------|---|
| Network                             | 2 × 1 Gb/s Ethernet etherCON I/Os   |
| General Purpose I/O (GPIO)          | 1 × 10-point terminal block:<br>4 configurable inputs (optocouplers) / outputs (relay), fully isolated<br>1 ground pin, 3 chassis ground pins   |
| Service port                        | 1 Micro USB   |
| L-Acoustics remote control software | LC16D embedded Web interface, available through a network or USB connection<br><br>L-Acoustics Device Scanner, used with a network connection<br><br>USB Terminal, used with a USB connection |

## Interface

|                            |  |
|----------------------------|--|
| Status indicators          | 1 single color LED for power                         |
|                            | 1 single color LED for PoE (Power over Ethernet)     |
|                            | 1 dual color LED for L-NET                           |
|                            | 1 dual color LED for status                          |
| Clock reference indicators | 1 single color LED for internal clock                |
|                            | 1 single color LED for word clock                    |
|                            | 1 single color LED for Milan-AVB clock               |
|                            | 1 single color LED for MADI clock                    |
|                            | 1 single color LED for AES/EBU 1 clock               |
| Input indicators           | 8 dual color LEDs for AES/EBU inputs (one per pair)  |
|                            | 1 dual color LED for MADI inputs                     |
| Output indicators          | 8 dual color LEDs for AES/EBU outputs (one per pair) |
|                            | 1 dual color LED for MADI outputs                    |

## Input/output connectors

|   |   |
|---|---|
| AES/EBU outputs   | 1 DB25 female connector, AES59 8-way pinout annex C |
| AES/EBU inputs  | 1 DB25 female connector, AES59 8-way pinout annex C |
| MADI outputs  | 1 BNC connector, 75 $\Omega$ terminated             |
| MADI inputs   | 1 BNC connector, 75 $\Omega$ terminated             |
| Word clock output   | 1 BNC connector, 75 $\Omega$ terminated             |
| Word clock input  | 1 BNC connector, 75 $\Omega$ terminated             |
| Milan-AVB I/O,<br>network I/O, and PoE<br>(Power over Ethernet)<br>inputs | 2 x 1 Gb/s Ethernet etherCON I/Os                   |

## Storage and operating conditions

|                       |                                  |
|-----------------------|----------------------------------|
| Storage temperature   | -20 °C / -4 °F to 70 °C / 158 °F |
| Operating temperature | -5 °C / 23 °F to 50 °C / 122 °F  |
| Maximum altitude      | 2000 m                           |
| Climate               | moderate, tropical               |

## Physical data

|                   |              |
|-------------------|--------------|
| Height            | 1U           |
| Weight            | 2 kg/4.41 lb |
| Finish            | black        |
| Protection rating | IP3x         |

## LC16D dimensions

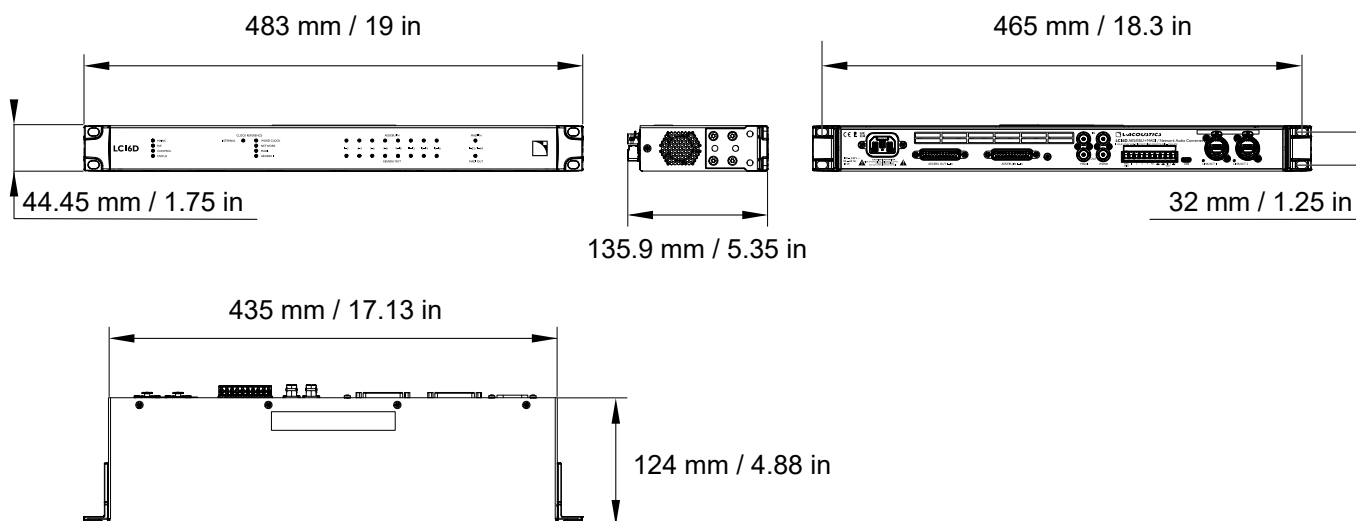



**L-Acoustics**

13 rue Levacher Cintrat - 91460 Marcoussis - France  
+33 1 69 63 69 63 - [info@l-acoustics.com](mailto:info@l-acoustics.com)  
[www.l-acoustics.com](http://www.l-acoustics.com)

 **L-ACOUSTICS**  
GROUP